

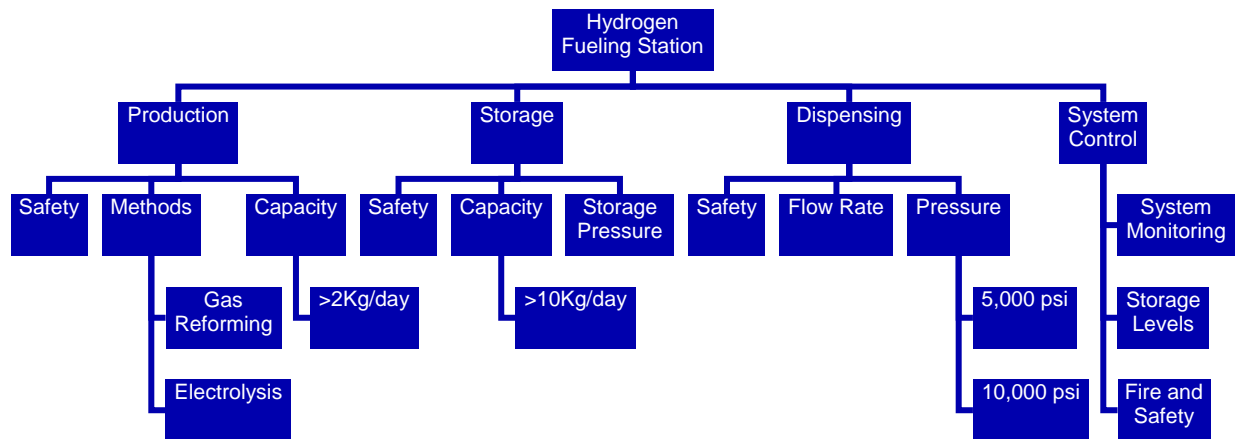

U.S. Department
of Transportation
**Federal Transit
Administration**

EAST TENNESSEE HYDROGEN INITIATIVE CHATTANOOGA

Charting a Course for the Region's Hydrogen Transportation Infrastructure



September 30, 2009

<http://www.fta.dot.gov/research>

Report No. FTA-TN-26-7032-2009.1

Report Documentation Page

1. AGENCY USE ONLY (LEAVE BLANK)	2. REPORT DATE September 30, 2009	3. REPORT TYPE AND DATES COVERED Final Report May 1, 2008 – June 30, 2009	
4. TITLE AND SUBTITLE East Tennessee Hydrogen Initiative—Chattanooga		5. FUNDING NUMBERS TN-26-7032	
6. AUTHOR(S) J. Ronald Bailey, PhD, P.E. and Mark E. Hairr			
7. PERFORMING ORGANIZATION NAME(S) AND ADDRESS(ES) Center for Energy, Transportation and the Environment University of Tennessee at Chattanooga 615 McCallie Avenue 214 EMCS Bldg., Dept. 2522 Chattanooga, Tennessee 37403-2598		8. PERFORMING ORGANIZATION REPORT NUMBER R041301029-001-10	
9. SPONSORING/MONITORING AGENCY NAME(S) AND ADDRESS(ES) U.S. Department of Transportation Federal Transit Administration Office of Research, Demonstration and Innovation 1200 New Jersey Avenue, SE Washington, DC 20590 http://www.fta.dot.gov/research		10. SPONSORING/MONITORING AGENCY REPORT NUMBER FTA TN-26-7032-2009.1	
11. SUPPLEMENTARY NOTES			
12a. DISTRIBUTION/AVAILABILITY STATEMENT This document is available to the public through the University of Tennessee at Chattanooga, University Relations, 615 McCallie Avenue, 203 Founders Hall, Dept. 5655, Chattanooga, Tennessee 37403, (423) 425-4363 (http://www.utc.edu) and The National Technical Information Service (NTIS), Springfield, VA, 22161; Phone: (703) 605-6000; FAX: (703) 605-6900; Email orders@ntis.gov		12b. DISTRIBUTION CODE	
13. ABSTRACT (Maximum 200 words) This report documents the results of the research project completed by the Center for Energy, Transportation and the Environment (CETE) at the University of Tennessee at Chattanooga (UTC) under Federal Transit Administration Cooperative Agreement TN-26-7032. This research has led to the design and implementation of a system for generating, compressing, storing and dispensing hydrogen in sufficient quantities to support testing of hydrogen fueled transit vehicles. This report provides background information on alternative fuels and compares various methods for producing hydrogen including nuclear energy, coal gasification, electrolysis and natural gas reformation. A simulation model was completed during the research project to relate energy consumption to power and energy storage requirements for transit vehicle operations. It includes an economic analysis for comparison of alternatives and a description of a rigorous decision making process that was used to select the various technologies used in the final configuration of a hydrogen fueling system that was optimized to support research on the use of hydrogen for transit vehicle operations.			
14. SUBJECT TERMS hydrogen, alternative fuels, public transportation, energy consumption, simulation model, economic analysis		15. NUMBER OF PAGES 53	
		16. PRICE CODE	
17. SECURITY CLASSIFICATION OF REPORT Unclassified	18. SECURITY CLASSIFICATION OF THIS PAGE Unclassified	19. SECURITY CLASSIFICATION OF ABSTRACT Unclassified	20. LIMITATION OF ABSTRACT



U.S. Department
of Transportation
**Federal Transit
Administration**

**EAST TENNESSEE HYDROGEN INITIATIVE
CHATTANOOGA**
September 30, 2009

Prepared by:

Center for Energy, Transportation and the Environment
University of Tennessee at Chattanooga
J. Ronald Bailey, PhD, P.E., Principal Investigator
Mark E. Hairr, Research Program Director
615 McCallie Avenue
214 EMCS Bldg., Dept. 2522
Chattanooga, Tennessee 37403-2598
(423) 425-5454

FINAL REPORT
Report No. FTA-TN-26-7032-2009.1



Sponsored by:

Federal Transit Administration
Office of Research, Demonstration and Innovation
U.S. Department of Transportation
1200 New Jersey Avenue, SE
Washington, DC 20590

Available Online

<http://www.fta.dot.gov/research>

FOREWORD

The research completed under Federal Transit Administration Cooperative Agreement TN-26-7032 has led to the design and implementation of a system for generating, compressing, storing and dispensing hydrogen in sufficient quantities to support testing of hydrogen fueled transit vehicles. This report provides background information on alternative fuels and compares various methods for producing hydrogen including nuclear energy, coal gasification, electrolysis and natural gas reformation. A simulation model was completed during the research project to relate energy consumption to power and energy storage requirements for transit vehicle operations. The report includes an economic analysis for comparison of alternatives and a description of a rigorous decision making process that was used to select the various technologies used in the final configuration of a hydrogen fueling system that was optimized to support research on the use of hydrogen for transit operations.

DISCLAIMER NOTICE

This document is disseminated under the sponsorship of the United States Department of Transportation in the interest of information exchange. The United States Government assumes no liability for its contents or use thereof.

The United States Government does not endorse products of manufacturers. Trademarks or manufacturers' names appear in the document only because they are essential to the objective of this report.

The University of Tennessee at Chattanooga is an equal employment opportunity/affirmative action/Title VI/Title IX/Section 504/ADA/ADEA institution.

ACKNOWLEDGEMENTS

This project was conducted under Federal Transit Administration (FTA) Cooperative Agreement TN-26-7032. Special recognition and appreciation is extended to the Chattanooga Enterprise Center staff and board and the Chattanooga Area Regional Transportation Authority (CARTA) both of which contributed greatly in the completion of this research program.

The project team also wishes to thank Mr. Henry Nejako, FTA Program Management Officer, Patrick Centolanzi, FTA Transportation Program Engineer, and the numerous UTC students, faculty and staff who assisted with many aspects of the projects completed under this work program.

Table of Contents

I. INTRODUCTION / BACKGROUND	1
<i>a. Energy Use in the Transportation Sector</i>	<i>2</i>
<i>b. Hydrogen Road Tour</i>	<i>4</i>
<i>c. FTA National Fuel Cell Bus Program</i>	<i>5</i>
<i>d. UT Chattanooga Hydrogen Research</i>	<i>6</i>
<i>e. Hydrogen Production Potential at UT Chattanooga</i>	<i>7</i>
II. RESEARCH APPROACH.....	7
<i>a. Methods for Hydrogen Generation.....</i>	<i>7</i>
i. Nuclear Energy	7
ii. Coal Gasification	8
iii. Reformation of Natural Gas.....	8
iv. Electrolysis	9
<i>b. Energy Simulator</i>	<i>9</i>
<i>c. Economic Analysis.....</i>	<i>10</i>
<i>d. Decision Making Criteria</i>	<i>13</i>
III. RESEARCH RESULTS-DESIGN FOR A HYDROGEN FUELING STATION	14
<i>a. Energy Analysis</i>	<i>14</i>
<i>b. Process and Instrumentation Diagram.....</i>	<i>14</i>
<i>c. Energy Analysis</i>	<i>15</i>
<i>d. On-site PEM Electrolysis.....</i>	<i>16</i>
<i>e. Compressors</i>	<i>16</i>
<i>f. Hydrogen Storage.....</i>	<i>16</i>
<i>g. Dispensing</i>	<i>18</i>
<i>h. Leak Detection.....</i>	<i>20</i>
<i>i. Site Location</i>	<i>21</i>
<i>j. Value Engineering and Analysis.....</i>	<i>26</i>
<i>k. Testing Requirements and Procedures</i>	<i>28</i>
<i>l. Safety and Standards</i>	<i>29</i>
i. General Design	29
ii. Equipment.....	30
iii. Barrier Walls	30
iv. Weather Protection	30
v. On-Site Production	31
<i>m. Hydrogen Safety.....</i>	<i>31</i>
<i>n. Budget Analysis</i>	<i>32</i>
<i>o. Environmental Issues.....</i>	<i>33</i>
IV. CONCLUSION	36

REFERENCES.....37

APPENDIX A-Hydrogen Production Cost Model.....40

APPENDIX B-List of Acronyms41

APPENDIX C-Metric Conversion Chart42

LIST OF FIGURES

Figure 1. University of Tennessee at Chattanooga Transportation Research Roadmap..... 1

Figure 2. Energy Use in the United States 2

Figure 3. Consumption of Petroleum by Transportation Sector 3

Figure 4. Penetration Curves for Hydrogen Fuel Cell Vehicles 3

Figure 5. Distribution of Hydrogen Fueling Stations in the United States 4

Figure 6. National Hydrogen Road Tour Event in Chattanooga 5

Figure 7. Solid Oxide Fuel Cell 6

Figure 8. Cost Equivalence for Diesel vs. Hydrogen ICE 12

Figure 9. Cost Equivalence for Diesel ICE vs. Hydrogen Fuel Cell 12

Figure 10. Process Diagram 15

Figure 11. Hydrogen Dispensing Unit (Source: Fueling Technologies Inc.) 20

Figure 12. CETE Advanced Vehicle Test Facility Building 22

Figure 13. CETE Advanced Vehicle Test Facility Track 22

Figure 14. CARTA Electric Bus Facility 23

Figure 15. UTC SIM Center 23

LIST OF TABLES

Table 1. Simulator Model Variable Definitions 10

Table 2. Pressure Dispersment 17

Table 3. Specification for a Hydrogen Dispensing Unit (Source: Fueling Technologies Inc.) 19

Table 4. Location Matrix 24

Table 5. AVTF Location Metrics 25

Table 6. Function Analysis for Refueling Station 26

Table 7. Cost-Function Matrix for Major Components 27

Table 8. Carbon Dioxide Emissions for Various Hydrogen Production Methods 34

ABSTRACT

This report documents the results of the research project completed by the Center for Energy, Transportation and the Environment (CETE) at the University of Tennessee at Chattanooga (UTC) under Federal Transit Administration Cooperative Agreement TN-26-7032. This research has led to the design and implementation of a system for generating, compressing, storing and dispensing hydrogen in sufficient quantities to support testing of hydrogen fueled transit vehicles. This report provides background information on alternative fuels and compares various methods for producing hydrogen including nuclear energy, coal gasification, electrolysis and natural gas reformation. A simulation model was completed during the research project to relate energy consumption to power and energy storage requirements for transit vehicle operations. It includes economic analysis for comparison of alternatives and a description of a rigorous decision making process that was used to select the various technologies used in the final configuration of a hydrogen fueling system that was optimized to support research on the use of hydrogen for transit operations.

EXECUTIVE SUMMARY

The East Tennessee Hydrogen Initiative (ETHI) is an integrated research program intended to advance the understanding and use of hydrogen in public transportation in the Chattanooga region. This report documents research to support the ETHI performed by the Center for Energy, Transportation and the Environment (CETE) at the University of Tennessee at Chattanooga (UTC) under Federal Transit Administration Cooperative Agreement TN-26-7032. Specifically, this cooperative agreement funded research for the following activities:

- To conduct a comparison of various methods for producing hydrogen including nuclear energy, coal gasification, natural gas reformation and electrolysis;
- To develop a simulation model to relate energy consumption to power and energy storage requirements for the transit vehicle operations;
- To develop an economic model to analyze and estimate the cost of hydrogen production by electrolysis compared to large scale production costs associated with coal gasification and natural gas reformation; and
- To provide a description of a rigorous decision making process that was used to select the various technologies used in the final configuration of a hydrogen fueling system that was optimized to support research on the use of hydrogen for transit vehicle operations.

This research has led to the design and implementation of a system for generating, compressing, storing and dispensing hydrogen in sufficient quantities to support testing of hydrogen fueled transit vehicles.

The first task under this research project was focused on exploring alternative fuel options for renewable transportation energy at a time of growing concern for the cost of fuel driven by increased demand, coupled with concerns for national security and climate change caused by human activity, especially burning of fossil fuels. Hydrogen is the most abundant element in the universe, but it seldom exists in a pure molecular form because of its volatile nature. Hydrogen can be produced from a number of chemical reactions, including coal gasification, reformation of natural gas, and electrolysis of water. Coal gasification and reformation of natural gas are the most economical means of large scale production today, but both require infrastructure to transport the hydrogen from the production site to the point of use. Existing natural gas pipelines cannot be used for this purpose because of the corrosive nature of hydrogen and the tendency for hydrogen to cause carbon steel to become brittle from prolonged contact with hydrogen. The low density of gaseous hydrogen requires either transportation in a super cooled liquid state or compression. Clearly, coal gasification cannot be implemented on a university campus. While it has been demonstrated that natural gas reformation is feasible on the UTC campus, there is no source of natural gas at the Advanced Vehicle Test Facility (AVTF) which will be used for much of the testing of the new hydrogen hybrid shuttle bus being developed by CETE under FTA Cooperative Agreement TN-26-7034. However, the AVTF has an abundance of electricity due to its prior use as a test site for development of electric vehicles so it is feasible to produce small quantities of hydrogen through electrolysis at this site.

Once hydrogen production methods were analyzed, CETE developed a Topographical Inertial Energy Simulator (TIES) as a design tool to assist in evaluating hybrid transit vehicle

technologies, particularly as energy consumption relates to power and energy storage. The TIES incorporates topography and curvature of a planned route, vehicle weight, requirements for acceleration and instantaneous speed, aerodynamic drag and rolling resistance, and overall energy efficiencies for each of the components that make up the drive train of a hybrid transit vehicle. When used in conjunction with models of the energy conversion processes required to charge and discharge electrical components (batteries and ultracapacitors) and models of the overall “well to wheel” efficiency characteristics of petroleum based fuels, TIES can be used to compare predicted performance of hybrid electric transit vehicles that use various combinations of internal combustion engines, fuel cells, ultracapacitors, and batteries.

During the course of this research project, CETE narrowed its focus to the evaluation of two different hydrogen production methods for use at the CETE Advanced Vehicle Test Facility (AVTF), including natural gas reformation and electrolysis. During the evaluation, several advantages and disadvantages were identified for natural gas reformation and electrolysis. Although there are advantages of natural gas reformation, the analyses revealed that electrolysis is the best production method for the ETHI as it is cost-effective, especially when renewable energy is used. With the exception of hydroelectric power, renewable energy sources account for less than one percent of the electricity generated in the U.S. When renewable energy is not available the electricity needed to power the electrolyzer will have to be purchased. An electrolyzer with an efficiency of 75% can produce hydrogen for \$4.24 per kilogram of hydrogen. This cost is based on an electrolyzer being powered by electricity with a retail cost of 8 cents per kilowatt hour.

In order to analyze production and storage issues for this project, a model called “source to pump analysis” was established. Stated differently, the analysis included everything from the production of hydrogen to its storage and delivery. There are six key criteria to this model including start up cost, fossil fuel use, total energy use, operating efficiency, greenhouse gas emissions and last, but certainly not least, safety. Additionally, the energy balance of a hydrogen production facility was identified as a critical issue in the design process because of its importance in revealing the energy gains and consumption throughout the entire process. After ruling out various production methods such as coal gasification and natural gas reformation, Proton Exchange Membrane (PEM) electrolysis was selected as the desired production method. CETE conducted a materials and mass flow balance analysis to assist with achieving the goal of determining how much water must be used to produce the 2kg of H₂ stipulated in the design objectives.

As a major constituent of the final design phase for the hydrogen production system, CETE developed an economic analysis that produced estimated annual costs. As the design goes from concept to realization an economic assessment must accompany. The analysis examined capital costs and operating costs, providing a total annual cost of the hydrogen production facility. This cost figure, divided by the yearly production of hydrogen, gives a cost per kilogram for the system. The total operating costs per year were calculated to be \$6,248. This is added to the annualized capital cost for a total yearly cost \$44,500, or \$53.77 per kilogram of hydrogen. If capital costs are not considered, the cost is \$8.00 per kilogram. It is apparent that much work needs to be done in order for electrolysis to be an economically viable method of hydrogen production, with the capital cost being the single largest hurdle. This is due primarily to the

relatively low number of systems built each year as reflected in an installed base of less than 100. However, for research purposes, the electrolysis based system will meet the basic requirements while staying within the budget constraints of this particular research project.

In summary, the requirement to design and build a hydrogen fueling station that is capable of producing 2 kg of hydrogen day while storing 10 kg has been met. The major components have been acquired by CETE and system integration is underway, with a goal to have the fueling station commissioned by the end of October 2009. This hydrogen fueling station will be a critical element in the overall East Tennessee Hydrogen Initiative and contribute to further hydrogen research as CETE develops a hydrogen hybrid transit vehicle under FTA Cooperative Agreement TN-26-7034.

I. INTRODUCTION / BACKGROUND

The East Tennessee Hydrogen Initiative is part of a larger, integrated applied research program at the University of Tennessee at Chattanooga. This report covers activities for Federal Transit Administration (FTA) Cooperative Agreement TN-26-7032 that are highlighted in blue in the diagram below, which shows the relationship that this Cooperative Agreement has with TN-26-7021, TN-26-7031, and TN-26-7034.

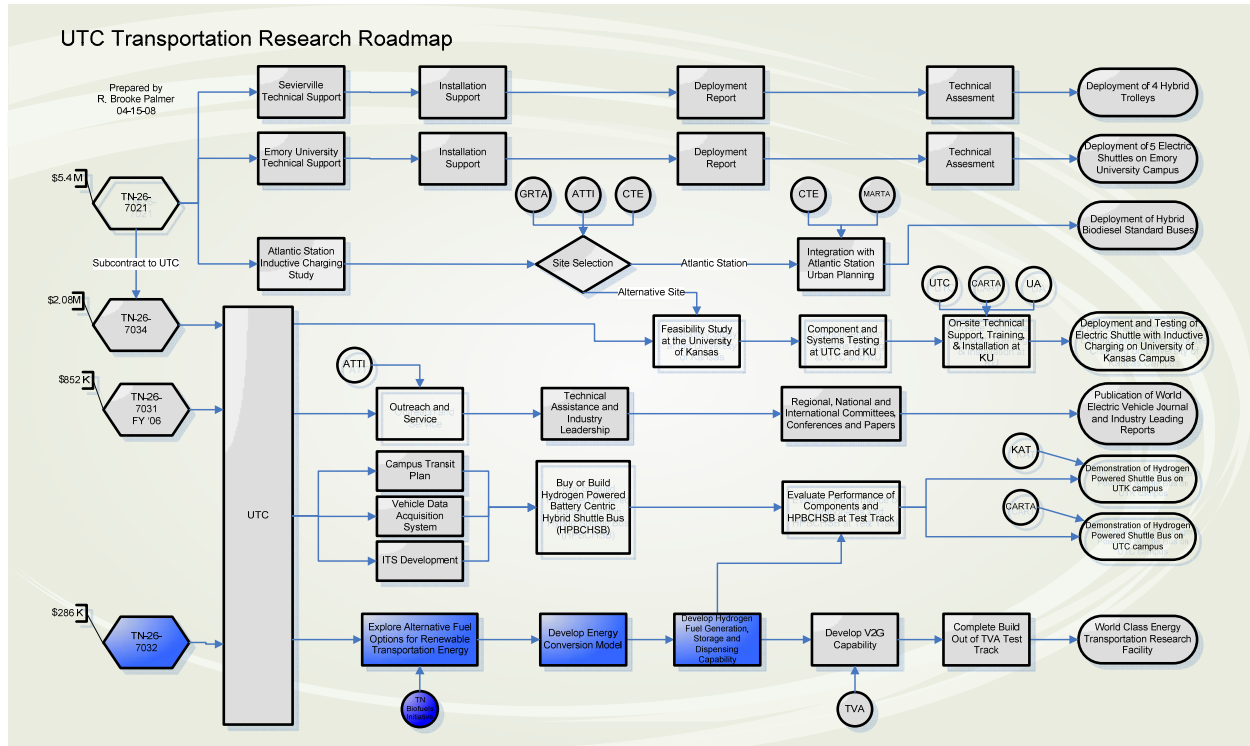

Figure 1. University of Tennessee at Chattanooga Transportation Research Roadmap

This research supports the long range goal proposed by the President to invest more than \$150 billion in research and development over the next ten years to transition to a clean energy economy. The benefits of hydrogen as an energy carrier for advanced vehicles are significant enough to ensure it will be an important part of clean energy solutions of the future. Additionally, the research conducted by CETE addresses several of the major goals identified by the U.S. Department of Transportation (USDOT) and the FTA, namely those of environmental stewardship (i.e., energy efficiency and alternative fuels); use of high-efficiency technologies and alternative energy sources; and the reduction of environmental impacts (e.g., emissions) from the public transportation sector. This research directly addresses these initiatives as hydrogen is a clean domestic resource, and it is anticipated that continued investments being made in hydrogen infrastructure and fuel cell technology will benefit the transit industry by reducing the cost of fuel cells for transportation. Likewise, the rollout of hydrogen fueled automobiles will also promote the deployment of more hydrogen fueling stations resulting in a benefit across the transportation sector.

a. Energy Use in the Transportation Sector

The first task for this cooperative agreement was focused on exploring alternative fuel options for renewable transportation energy at a time of growing concern for the cost of fuel driven by increased demand, coupled with concerns for national security and climate change caused by human activity, especially burning of fossil fuels. Numerous factors have influenced the increase in oil prices throughout the world, with current prices being higher than ever before. Military actions in the Middle East along with severe weather phenomena have caused oil prices to skyrocket over the last ten years. While the cost of oil has increased, so has the nation’s consumption.¹ In 2007 the United States imported nearly 55% of the oil it consumed. According to the Department of Energy (DOE) this amount is expected to increase to nearly 57% by the year 2025.² This has led academic and government leaders to examine alternate energy sources that are both abundant and environmentally friendly. A presentation by the Undersecretary of the U.S. Department of Energy, David Garman in July 2005 at the Tennessee Valley Summit meeting held in Washington D.C. illustrates the critical need for alternative fuels for transportation.

The following figure illustrates the fact that residential and industrial energy use is supplied by a variety of fuels including nuclear, renewable, natural gas and coal. Yet the transportation industry is predominately dependent on the use of oil, a majority of which is provided by imports from other countries.

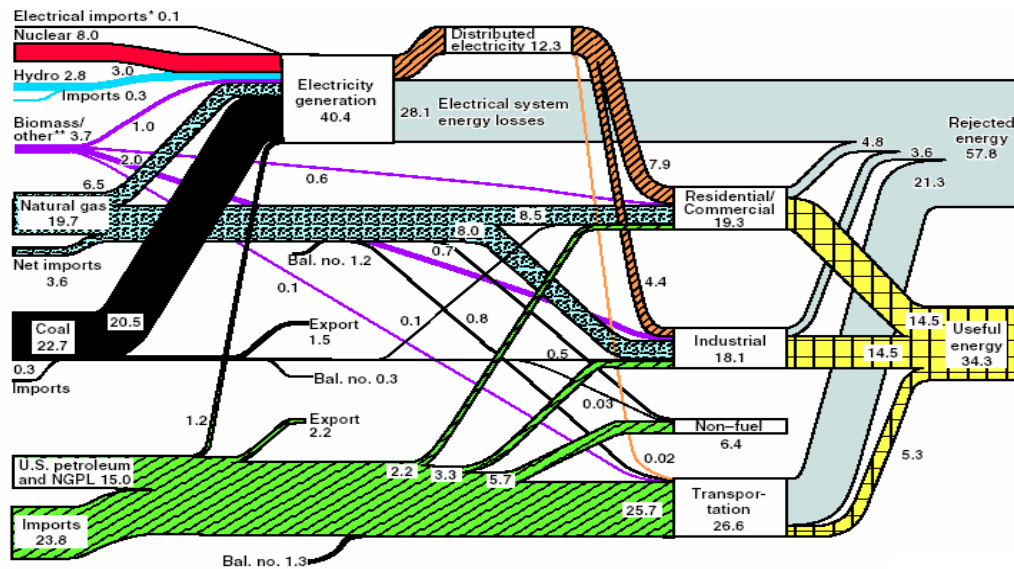

Figure 2. Energy Use in the United States

¹ “Daily Fuel Gauge Report.” [AAA's Media Site for Retail Gas Prices](http://www.fuelgauge.com/tnavg.asp). 14 Oct. 2008. AAA. 14 Oct. 2008

² “Petroleum Basic Statistics.” [Energy Information Administration](http://www.eia.doe.gov/basics/quickoil.html). Sept. 2008. U.S. Department of Energy. 14 Oct. 2008

Further, the gap between domestic oil production and the total consumption of oil in the transportation sector has been increasing since 1985 and continues to increase as shown in the graphic below.

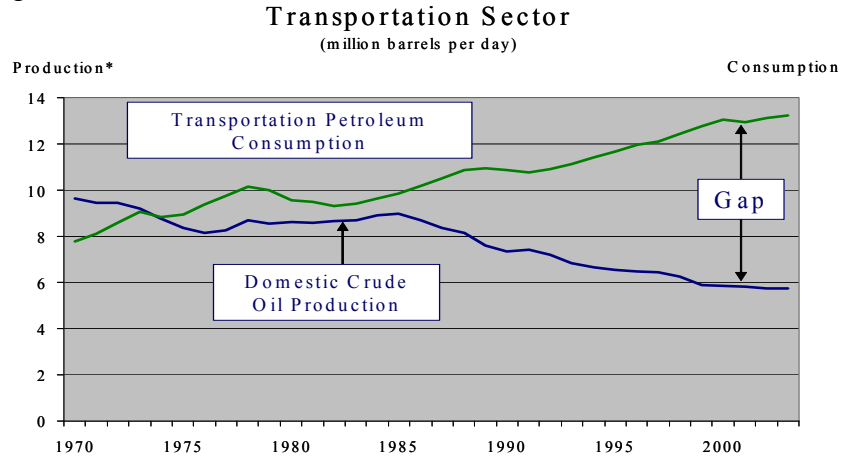
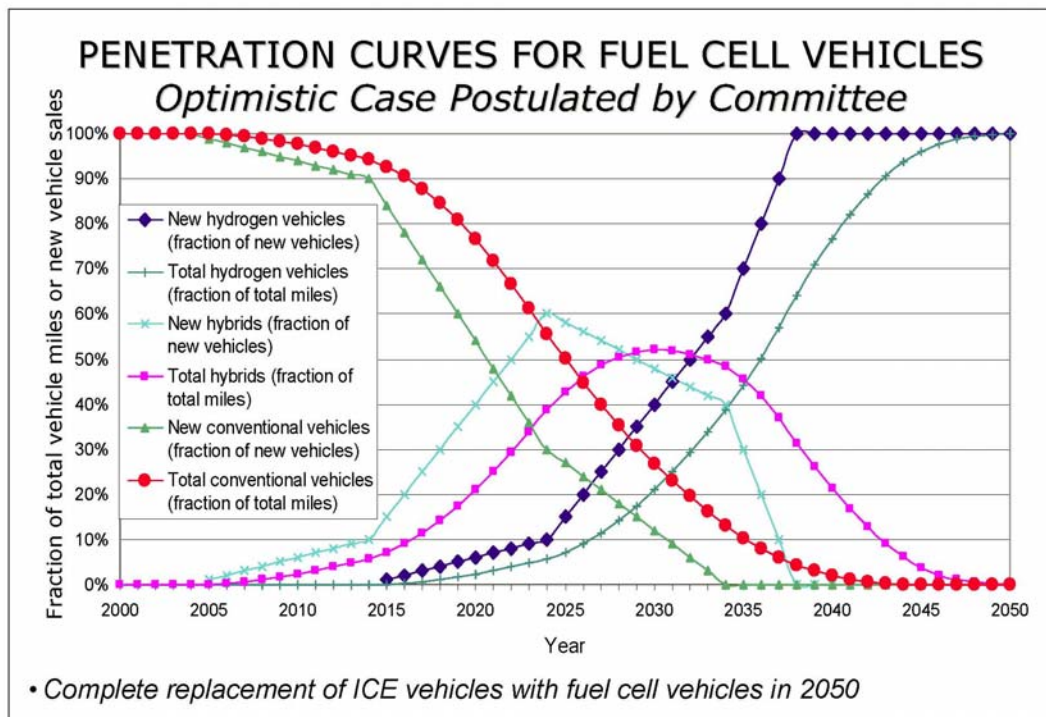

Figure 3. Consumption of Petroleum by Transportation Sector

In response to the decline in domestic production of petroleum, coupled with growing concerns about national security and climate change due to human activity, the National Academies conducted a study for Congress that projected the emergence of hydrogen as a sustainable fuel for transportation. The diagram below from that study suggests that vehicles powered by internal combustion engines will disappear by the middle of the 21st century, replaced first by hybrid vehicles, followed by hydrogen fuel cell vehicles.



THE NATIONAL ACADEMIES

24

Figure 4. Penetration Curves for Hydrogen Fuel Cell Vehicles

Several automobile manufacturers, including General Motors, Honda, Toyota, Ford, GM, and BMW have demonstrated hydrogen fueled vehicles.³ In parallel to development of hydrogen powered vehicles, modest progress has been made in establishing hydrogen fueling stations. The map in Figure 5 indicates that most of these hydrogen fueling stations have been built in California which has the added incentive of long standing initiatives aimed at improving air quality. None of the existing hydrogen fueling stations is closer than 400 miles from Chattanooga, Tennessee.

b. Hydrogen Road Tour

Early in the 20th century, a number of “Grand Tours” were organized in the early days of the automotive industry to promote internal combustion engine cars. This was done at a time when gasoline fueling stations were not readily available across the nation. In a move reminiscent of those “Grand Tours,” a National Hydrogen Road Tour was organized in 2008 to promote the use of hydrogen as a clean alternative to petroleum as fuel for transportation. This tour began in Connecticut and ended in California. In order to travel through parts of the country that did not have hydrogen fueling stations, three portable hydrogen fueling stations accompanied the hydrogen powered cars on the tour. One of these carried liquid hydrogen which was used by a BMW automobile powered by a converted internal combustion engine. The other two portable fueling stations carried compressed hydrogen that was used by the remaining fuel cell powered automobiles.

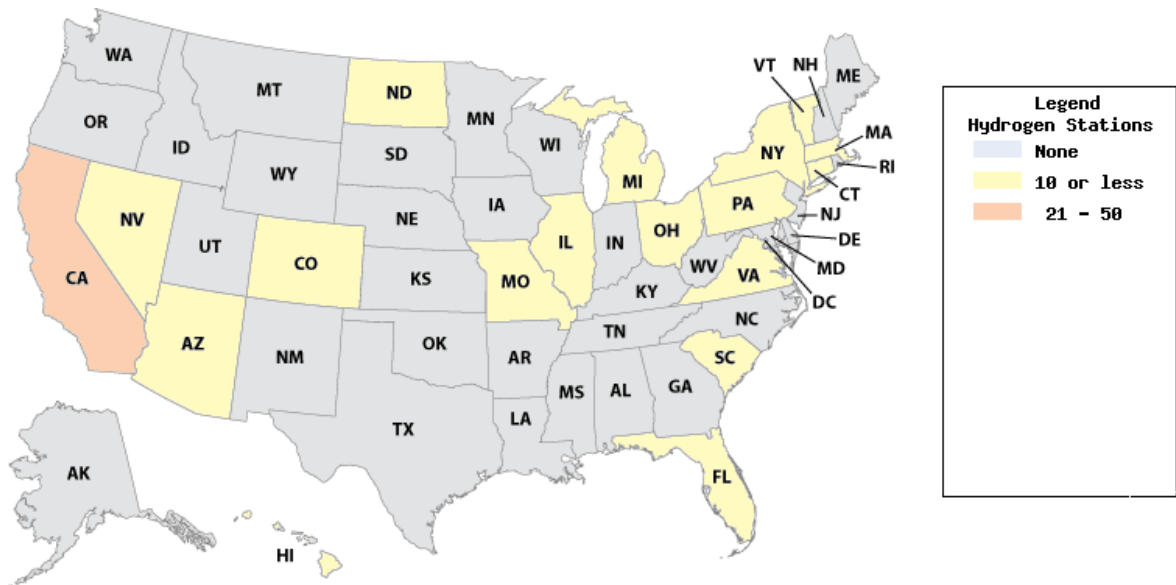

Figure 5. Distribution of Hydrogen Fueling Stations in the United States

The CETE hosted the National Hydrogen Road Tour when it passed through Chattanooga. Shown below are Cheryl McQueary, Deputy Administrator, U.S DOT Research and Innovative Technology Administration, speaking at the event in

³ “Hydrogen Road Tour '08.” *31 States in 18 Cities in 13 Days*. 2008. U.S. Department of Transportation (US DOT). 14 Oct. 2008 <http://hydrogenroadtour08.dot.gov/>.

Chattanooga. With Ms. McQueary, from right to left, are CETE Director, Dr. Ron Bailey, United States Congressman Zach Wamp and Chattanooga Mayor Ron Littlefield.



Figure 6. National Hydrogen Road Tour Event in Chattanooga

It is anticipated that continued investments being made in fuel cell technology and hydrogen infrastructure will benefit the transit industry by reducing the cost of fuel cells for transportation. Likewise, the rollout of hydrogen fueled automobiles will also promote the deployment of more hydrogen fueling stations.

c. FTA National Fuel Cell Bus Program

For the transit industry, a major hydrogen initiative has been the Federal Transit Administration’s National Fuel Cell Bus Program.⁴ An alternative method of using hydrogen as a fuel for transportation is to convert a conventional internal combustion engine to run on hydrogen. Both fuel cells and converted internal combustion engines produce only water, eliminating all harmful tail pipe emissions. In addition to several automobiles that use this approach, a small fleet of hydrogen fueled, ICE shuttle buses have been deployed at the airport in Orlando Florida.⁵ These vehicles are attempting to take advantage of lower cost and higher reliability from leveraging the economies of scale associated with mass production of internal combustion engines. The trade off is lower fuel economy, but that can be mitigated by integrating the hydrogen fueled internal combustion engine into a battery dominant hybrid electric vehicle as a range extender. There is a bus manufactured by New Flyer in partnership with ISE Corporation that has an internal combustion based hydrogen fueled hybrid bus that incorporates ultracapacitors with an electric drive system. This has the advantage of being a zero emission vehicle, but does not take advantage of advances in battery technology that could result in a more sophisticated hybrid design.

⁴ National Fuel Cell Bus Technology Program, Federal Transit Administration, Section 3045 of the Safe, Accountable, Flexible, Efficient Transportation Equity Act: a Legacy for Users (SAFETEA-LU), 2006.

⁵ “Ford Launches Production of Hydrogen Internal Combustion Engines for Delivery Customers,” Electric Drive Transportation Association Website Article, July 17, 2004 (www.electricdrive.org).

d. UT Chattanooga Hydrogen Research

UTC, in partnership with the Chattanooga Area Rapid Transit Authority (CARTA), is in the process of planning a demonstration of a hydrogen fueled internal combustion engine powered, battery centric shuttle bus under a parallel Cooperative Agreement (TN-26-7034) with the Federal Transit Administration. This project requires a modest hydrogen fueling capability in order to support the testing necessary for a successful demonstration project. Shown below is a Solid Oxide Fuel Cell (SOFC) that was installed at the UTC SimCenter in early 2006.



Figure 7. Solid Oxide Fuel Cell

This SOFC was built by Ion America (now Bloom Energy) under a grant from the U.S. DOE. It was tested for more than 1000 hours over a two year period under a range of power loads and operating conditions. While it has the capability to generate hydrogen for purposes other than generating electricity, the necessary storage and compression capabilities was not implemented. Only natural gas was used as a feed stock for these experiments, which were focused on the efficiency of the SOFC for generating electricity.

When the East Tennessee Hydrogen Initiative was first conceived, it was thought that this SOFC could be modified to serve as a hydrogen fueling station, perhaps taking advantage of the newly formed Center of Excellence in Biofuels at the University of Tennessee at Knoxville which intends to produce cellulosic ethanol from switch grass and other agriculture products. However, the start of the new Center of Excellence has been delayed, causing the large scale production of cellulosic ethanol to be at least two years away. In addition, the DOE sponsored demonstration of the SOFC ended in 2007. At this point, the SOFC would have to be reconditioned and reconfigured to use it as a source of hydrogen to fuel UTC's hybrid shuttle bus demonstration under TN-26-7034. An evaluation of the situation led to a decision that an alternative means of producing, storing and dispensing hydrogen was desirable. After considerable analysis, as outlined in the following sections of this report, it was decided that both UTC and UTK would design and build a hydrogen fueling system based on electrolysis.

e. Hydrogen Production Potential at UT Chattanooga

As pointed out in the report by the National Academies, hydrogen is the most abundant element in the universe, but it seldom exists in a pure molecular form because of its volatile nature. Hydrogen can be produced from a number of chemical reactions, including coal gasification, reformation of natural gas, and electrolysis of water. Coal gasification and reformation of natural gas are the most economical means of large scale production today, but both require infrastructure to transport the hydrogen from the production site to the point of use. Existing natural gas pipelines cannot be used for this purpose because of the corrosive nature of hydrogen and the tendency for hydrogen to cause carbon steel to become brittle from prolonged contact with hydrogen. The low density of gaseous hydrogen requires either transportation in a super cooled liquid state or compression. Clearly, coal gasification cannot be implemented on a university campus. While it has been demonstrated that natural gas reformation is feasible on the UTC campus, there is no source of natural gas at the Advanced Vehicle Test Facility (AVTF) which will be used for much of the testing of the new hybrid shuttle bus. However, the AVTF has an abundance of electricity due to its prior use as a test site for development of electric vehicles so there may be an opportunity to produce small quantities of hydrogen through electrolysis at this site.

II. RESEARCH APPROACH

The East Tennessee Hydrogen Initiative was conceived as a partnership between the University of Tennessee at Chattanooga and the University of Tennessee at Knoxville to develop a modest hydrogen fueling capability for the eastern region of Tennessee to support applied research on both campuses aimed at demonstrating a new hydrogen powered hybrid shuttle bus for campus transit operations.

The first task was to develop an overall understanding of **Methods for Hydrogen Generation, Storage, and Dispensing**. This was followed by development of a **Simulator** to relate energy consumption to power and energy storage requirements. An **Economic Model** was developed that can be used to estimate the cost of hydrogen production by electrolysis for comparison with large scale production costs associated with coal gasification and natural gas reformation. In order to optimize the final design, **Decision Making Criteria** were established for the fueling system. The final task was to **Design and Build a Hydrogen Fueling System** capable of supporting the applied hydrogen research planned under TN-26-7034.

a. Methods for Hydrogen Generation

i. Nuclear Energy

Nuclear power plants not only produce electricity, but they also produce high temperature heat that could be used to facilitate production of hydrogen by electrolysis. High temperature electrolysis has the potential to produce hydrogen

with an overall system efficiency of 45-55%,⁶ without fossil fuel consumption or production of green house gases. With this level of efficiency, a typical 1000 megawatt nuclear power plant could produce up to 28,000 kilograms of hydrogen per hour. At a wholesale rate of \$.04 per kWh, the value of the electricity for one hour of operation would be about \$40,000, neglecting transmission losses. Therefore, the wholesale price of hydrogen would need to be more than \$1.43 per kilogram for this method of production to be economically feasible.

ii. Coal Gasification

Coal is an abundant and inexpensive domestic resource. The U.S. has a larger coal reserve than any other country in the world, roughly a 245 year supply based on current consumption.⁷ Coal accounts for approximately 50% of the electricity produced in the U.S. today. This electricity is acquired from a coal combustion process, which releases carbon dioxide and other emissions. The cost of hydrogen production at a central gasification plant devoted to hydrogen production is estimated to be \$1.03/kg of hydrogen at the plant gate with carbon dioxide sequestration.⁸ A challenge facing this process is dealing with the large scale CO₂ sequestration. An integral coal gasification plant with carbon capture sequestration (CCS) has not yet been adequately demonstrated.⁹

iii. Reformation of Natural Gas

Steam methane reforming is a process in which natural gas is used to produce hydrogen gas. First, the natural gas is treated with hydrogen to remove sulfur. The sulfur stream bi-product is scrubbed and then released into the atmosphere. Then the natural gas is mixed with high temperature steam (700-1000°C) at 3-25 bars of pressure over a nickel-alumina catalyst. The reaction produces hydrogen gas and carbon monoxide.

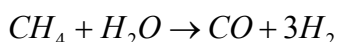

A water-gas shift reaction follows. The carbon monoxide and more steam then react in two stages. First, a high temperature shift occurs at approximately 350°C. A low temperature shift follows at approximately 190-200°C. In this process, the carbon monoxide and steam produce carbon dioxide and more hydrogen.

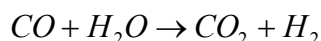

⁶ Besenbruch, G.E. "High Efficiency Generation of Hydrogen," OECD/NEA, Information Exchange Meeting on the Nuclear Production of Hydrogen, 2 Oct. 2000, Paris, France. 14 Oct. 2008 <http://web.gat.com/pubs-ext/misconf00/a23510.pdf>.

⁷ Canine, Craig. "How to Clean Coal." *OnEarth*. Fall 2005. Natural Resources Defense Council. 14 Oct. 2008 <http://www.nrdc.org/onearth/05fal/coal1.asp>

⁸ National Research Council (U.S.). "Hydrogen Production Technologies." *The Hydrogen Economy : Opportunities, Barriers, and R&D Needs*. New York: National Academies P, 2004. 91-105.

⁹ "Gasification Technology R&D." *U.S. Department of Energy*. 10 Sept. 2008. U.S. Department of Energy. 14 Oct. 2008 <http://fossil.energy.gov/programs/powersystems/gasification/index.html>.

Finally, in the pressure-swing adsorption, CO₂ and impurities are removed and discarded appropriately.

iv. Electrolysis

Electrolysis is the passage of an electric current through an electrolyte with subsequent migration of positively and negatively charged ions to the negative and positive electrodes.

One of the greatest advantages to electrolysis is that it can produce hydrogen from the most abundant natural resource on earth: H₂O. This clean and efficient process also has minimal impact to the environment, because the only by-product to electrolysis is oxygen.

Electrolysis has been used for many years to produce hydrogen. An important issue with electrolysis is the ratio of hydrogen production to power consumption. Electrolyzers are available in a wide range of production capacities. The electrolyzer generates hydrogen at low pressures ([200psi). This in turn requires the use of compressors and moderate sized storage tanks in order to supply H₂ at the desired pressure.

There are currently two types of commercially available electrolyzers: the alkaline electrolyzer, which uses potassium hydroxide (KOH) as its electrolyte, and the proton exchange membrane (PEM) electrolyzer which uses a solid state polymer electrolyte. Regardless of the method employed, the electrolytic reaction can be summarized as:

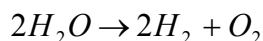

b. Energy Simulator

A Topographical Inertial Energy Simulator (TIES) has been developed as a design tool that incorporates topography and curvature of a planned route, vehicle weight, requirements for acceleration and instantaneous speed, aerodynamic drag and rolling resistance, and overall energy efficiencies for each of the components that make up the drive train of a hybrid transit vehicle. When used in conjunction with models of the energy conversion processes required to charge and discharge electrical components (batteries and ultracapacitors) and models of the overall “well to wheel” efficiency characteristics of petroleum based fuels, TIES can be used to compare predicted performance of hybrid electric transit vehicles that use various combinations of internal combustion engines, fuel cells, ultracapacitors, and batteries.

The model has several visual basic scripts and Global Positioning System (GPS) coordinates are recorded along a specified transit route. Latitude, longitude and elevation are used to determine hills, curves, and turns in the route. The speed algorithm adjusts the vehicle speed to ensure the modeling of a comfortable ride for the passenger. It uses the shape of the coordinates, local speed limits, and vehicle limitations to arrive at a suitable speed for each interval. Interval speed is

used to find the power required to overcome counter forces. The following four equations are used to calculate these forces.

$$F_{elev} = mg \frac{\Delta e}{\Delta d} \quad (1)$$

$$F_{roll} = \mu_r mg \frac{\sqrt{\Delta d^2 + \Delta e^2}}{\Delta d} \quad (2)$$

$$F_{drag} = \frac{\rho}{2} v^2 C_d A_f \quad (3)$$

$$P_{inertia} = \frac{1}{2} m \Delta v^2 \quad (4)$$

The following table defines each variable used in the above referenced formulas.

Table 1. Simulator Model Variable Definitions

Variable	Definition
m	Vehicle Mass
g	Gravitational Force
e	Elevation
d	Distance Travelled
μ_r	Coefficient of Rolling Friction
C_d	Coefficient of Aerodynamic Drag
A_f	Frontal Area
ρ	Air Density
v	Current Speed

The forces are multiplied by the velocity, and the powers are summed. If $P_{inertia}$ or F_{elev} is negative, it is multiplied by the regenerative braking efficiency. Energy usage is calculated with the total power usage and interval time. This is the energy required to move the vehicle. This figure is now multiplied by the traction efficiency to find the energy consumption of the vehicle.

c. Economic Analysis

The stability of the U.S. economy is the primary reason for the need to use hydrogen as an energy source. Switching to an energy source that does not need to be imported would improve availability and security. Two different hydrogen production methods were evaluated for use at the UTC fueling station. The different methods were natural gas reformation and electrolysis.

There are several advantages associated with natural gas reformation. First, the reformation process is 56% efficient and could produce hydrogen for \$3.00 per kg.¹⁰ Second, pipelines used for transportation of methane are already in place.

¹⁰ Hydrogen Production “ Steam Methane Reforming (SMR).” HYDROGEN FACT SHEET. New York State Energy Research and Development Authority. 14 Oct. 2008
<http://www.getenergysmart.org/files/hydrogeneducation/6hydrogenproductionsteammethanereforming.pdf>

Third, the technology used in natural gas reformation is already widely in use. Ninety-five percent of the hydrogen produced in the US is produced using natural gas reformation.¹¹ Natural gas also has a high H to C ratio, which means that there will be less carbon dioxide emitted per kg of hydrogen produced.

Natural gas reformation does have its drawbacks. For one, natural gas is not renewable. The U.S. is currently importing 15% of their natural gas through pipelines from Canada and Mexico, and as Liquid Natural Gas (LNG) from Egypt, Nigeria, Trinidad and other countries.¹² Natural gas doesn't solve the dependence issue, it simply displaces it. Another issue is that natural gas reformation still emits 12 kg of CO₂ per kg of H₂ produced. Also, natural gas losses to the atmosphere are detrimental. Natural gas has a warming potential of 23. That means it contributes to the greenhouse effect 23 times more than CO₂. Natural gas reformation currently operates near the theoretical limit; therefore there is not much room for improvement.

Electrolysis is a production method that can be cost-effective, especially when renewable energy is used. With the exception of hydroelectric power, renewable energy sources account for less than one percent of the electricity generated in the U.S. When renewable energy is not available the electricity needed to power the electrolyzer will have to be purchased. An electrolyzer with an efficiency of 75% can produce hydrogen for \$4.24 per kilogram of hydrogen. This cost is based on an electrolyzer being powered by electricity with a retail cost of 8 cents per kilowatt hour.

When compared to diesel fuel, one kilogram of hydrogen has the energy equivalency of about 1 gallon of diesel fuel.¹³ In order for hydrogen to be an economically viable option, the cost to transit operations must be equal or preferably less than that of diesel fuel. A gallon of diesel fuel contains roughly the same amount of energy as a kilogram of hydrogen. The price equivalence of a kilogram of hydrogen and a gallon of diesel fuel can be calculated using a ratio of the mpg and mpg.

$$\frac{mpg_{H_2ICE}}{mpg_{gasICE}} * \frac{\$}{gal_{gas}} = \frac{\$}{kg_{H_2}}$$

This equation is represented graphically in Figure 8.

¹¹ "Today's Hydrogen Production Industry." U.S. Department of Energy Hydrogen Production Technology. 28 Oct. 2005. U.S. Department of Energy. 14 Oct. 2008

<http://www.fossil.energy.gov/programs/fuels/hydrogen/currenttechnology.html>

¹² "A Look At Some Of The More Promising Alternative Fuels." 2005. Natural Gas Liquid. 14 Oct. 2008

<http://www.naturalgasliquid.com/>

¹³ "Hydrogen Fueling Station Database." National Hydrogen Association: General Information. 14 Oct. 2008. NHA. 14 Oct. 2008 <http://www.hydrogenassociation.org/general/fuelingsearch.asp>

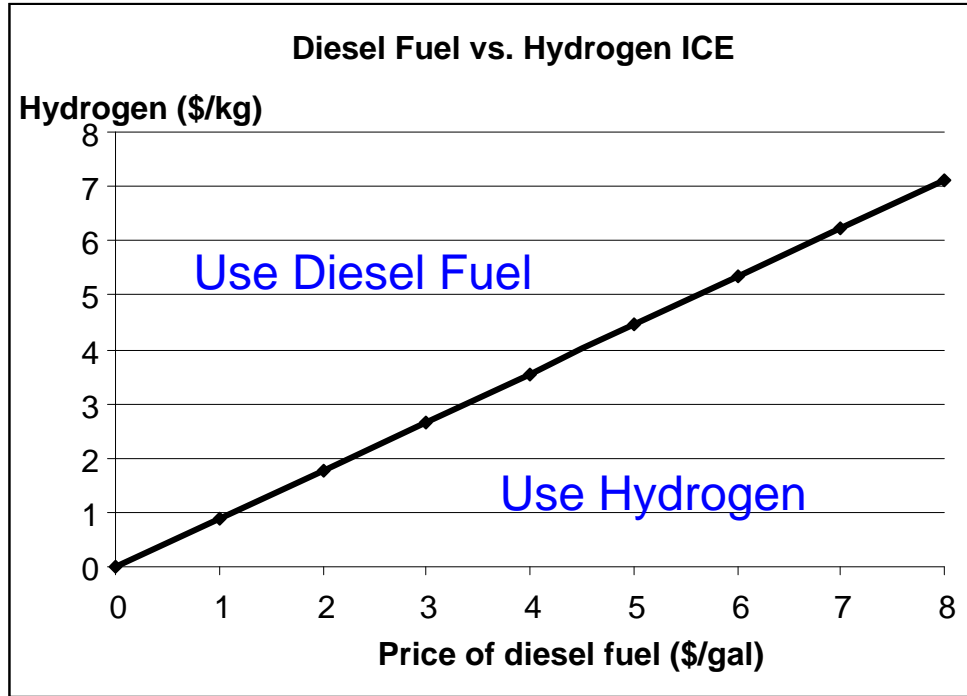

Figure 8. Cost Equivalence for Diesel vs. Hydrogen ICE

Ultimately, the hydrogen produced by the station would be used in fuel cell vehicles. The average efficiency for a fuel cell is approximately 3 times better than a diesel engine. This would give hydrogen a significant advantage over a diesel ICE as indicated by the price equivalence shown graphically in Figure 9.

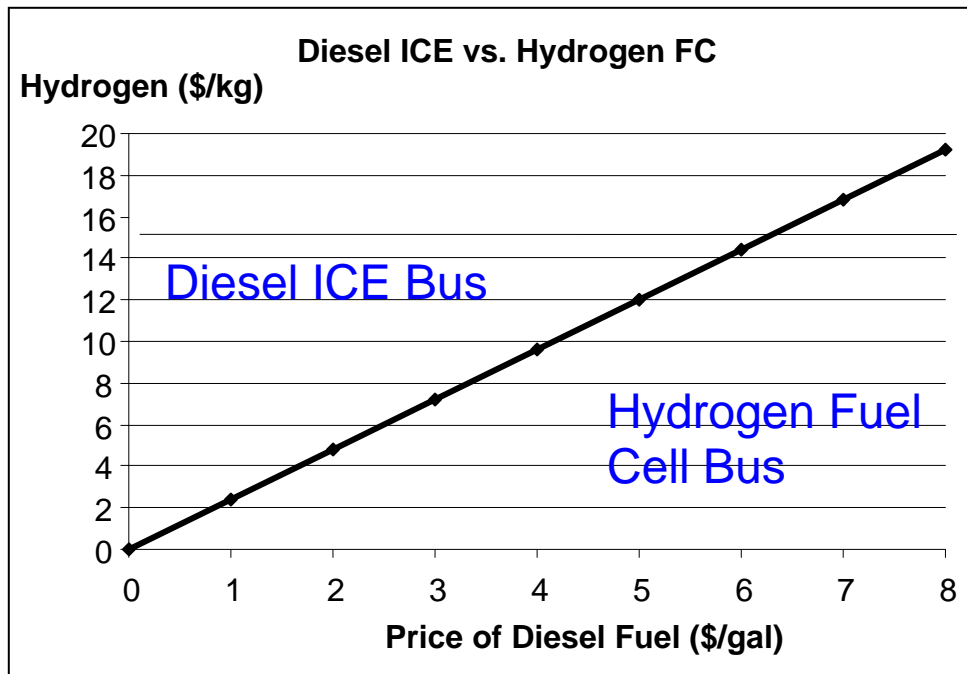

Figure 9. Cost Equivalence for Diesel ICE vs. Hydrogen Fuel Cell

d. Decision Making Criteria

Decision making criteria is essential in any design process. Keeping the scope of the project within guidelines is also important. In order to analyze production and storage for this project, a model called, “source to pump analysis” was established. Stated differently, the analysis will include everything from the production of hydrogen to its storage and delivery. There are six key criteria to this model. The first criteria is start up cost. The second and third are fossil fuel use and total energy use. Operating efficiency is the fourth criteria. Greenhouse gas emissions and safety are the final two criteria used in our decision making process.

Start up cost is the first and arguably most important criteria for deciding on a viable design. This primary cost is the limiting factor in the production and storage method selection. The initial investment must be justified for commitment to the project or it will be cancelled.

The use of fossil fuels is the second factor on our list of design criteria. A focus for this project is to decrease the dependence on foreign fossil fuels. Oil was eliminated as a production method for this very reason. Although natural gas reformation uses methane, a fossil fuel, technology is in place to efficiently produce hydrogen using this method. Also, the needed infrastructure, including gas pipes are currently in place making this a viable option. Coal gasification, while a viable method of producing hydrogen, is not economically feasible for production on a small scale.

Total energy use is also a major concern. This falls under the category of operating cost. It is critical to consider the amount of energy needed to produce 2kg of hydrogen per day. Also, a major concern is the amount of energy required to compress hydrogen to the needed pressure for storage and dispensing.

Operating efficiency is next on the list of criteria. Even if a production method is within the initial budget and its fossil fuel use is acceptable, its operating efficiency must be adequate. Operational and maintenance costs must be low when compared to the resulting income as well.

Regardless of the decisions made on previous criteria, the option chosen must adhere to all applicable safety codes and standards. Safety will not be sacrificed to lower production or maintenance costs.

III. RESEARCH RESULTS-DESIGN FOR A HYDROGEN FUELING STATION

a. Energy Analysis

The energy balance of a hydrogen production facility is a critical step in the design process. It reveals energy gains and consumption throughout the entire process. After ruling out various production methods such as coal gasification and natural gas reformation, PEM electrolysis was selected as the desired production method. The first step in an energy balance is to conduct a materials and a mass flow balance. The goal is to determine how much water must be used to produce the 2kg of H₂ stipulated in the design objectives. Once a material balance has been determined, the amount of energy required can be calculated.

A material balance revealed the need for 1000 moles (4.7 gallons) of water to theoretically produce 2 kg of H₂. Electrolyzer has an efficiency of 90% when converting water to H₂, thus the electrolyzer requires 5.2 gallons of water to produce 2 kg of H₂. Using 2260 kJ/kg as the heat of vaporization of water, calculations show that 45 MJ is required to vaporize 5.2 gallons of water in the purification process. This value assumes water is subsequently condensed without added energy expenditure.

Electrolyzer efficiency is the next step in the energy analysis of the production process. Efficiency is defined as the energy contained in a kg of H₂, 39 kWh, divided by the energy used by the electrolyzer to create 1 kg of H₂. Three major Electrolyzer manufacturers' average energy usage is 65kWh per kg of H₂. By dividing 39 by 65, an efficiency of 60% is obtained. Thus, to create 2kg of H₂, with a Higher Heating Value (HHV) of 284MJ, 473MJ must be used.

Energy losses are also associated with compressing the H₂ to 6000 psig+. An analysis of energy losses due to compression reveals that a multi stage compressor that achieves 6000 psi+ will also have an energy loss of approximately 10%. With a HHV of 284MJ, 2kg of H₂ would require 28MJ of energy to meet the compression requirements. An assumption that no hydrogen leakage occurs during any stage of production was made. With this assumption in place the energy usages for each step in the production line can be summed together. Thus, 545MJ was required to produce and store the required 2kg of hydrogen. Overall production efficiency was calculated to be 52%.

b. Process and Instrumentation Diagram

A Process and Instrumentation Diagram describes the interconnections of a particular process as well as the equipment and the instrumentation used to control the process (See Fig. 10).

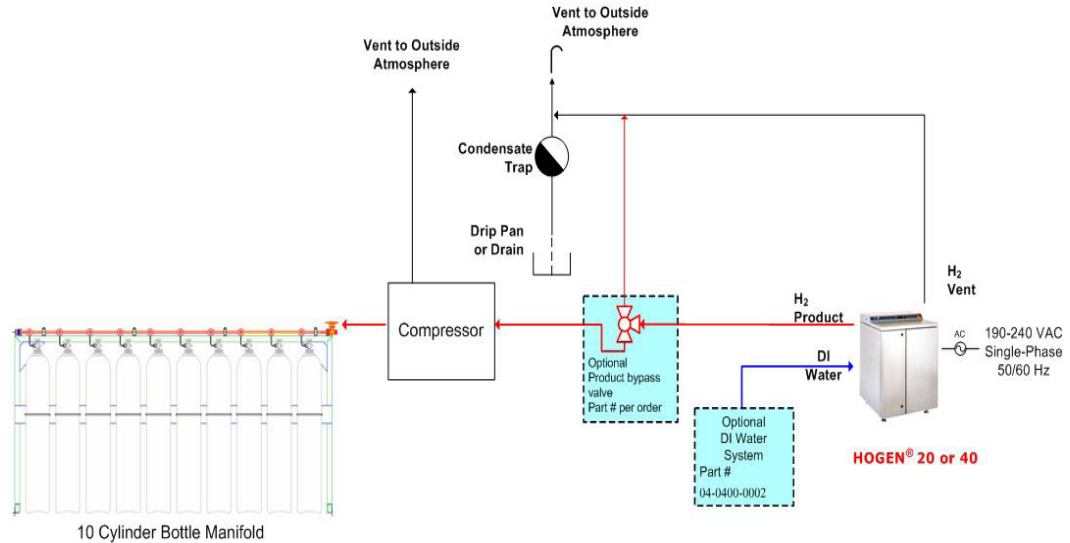

Figure 10. Process and Instrumentation Diagram

The Process and Instrumentation Drawing provided for the hydrogen fueling station will provide the team with helpful insight into the individual and sometimes intricate components of the fueling station. This particular Process Diagram is designed for two independent methods for acquiring hydrogen. The first of which is to purchase the hydrogen from a private vendor. This purchased hydrogen will be provided at 2000 psig and will be stored in a low pressure storage unit. The other option is to make the hydrogen on site. This process will be done with the use of a Hogen-40 electrolyzer. A direct water feed will go into a water purification unit and deionizer. This process removes all impurities and removes ions from the water. Next the purified water will move into the electrolyzer where the water molecules will be separated into hydrogen gas and oxygen gas. The oxygen gas can be expelled into the atmosphere or bottled and stored for future use. After the hydrogen is separated from the water it can then be stored in the same low pressure storage unit as previously discussed.

After the low pressure unit is filled, the gas can then be further compressed to its upper storage pressure of 5000 psig. This process is done by a high pressure diaphragm type compressor. Once the high pressure compression process is complete the hydrogen is then stored into the multi tank cascading storage system. The cascading system is a very unique system for distributing the hydrogen efficiently. Eleven electronic valves cycle the 10 tanks independently in order to efficiently distribute the 4.6kg of hydrogen at its required pressure of 5000psia.

c. Energy Analysis

This station will require a water purification unit. Ions in tap water could cause irreparable damage to the proton exchange membrane contained within the electrolyzer. There are several ways to obtain purified water. The two most common methods are distillation and reverse osmosis. Reverse osmosis is considered the most economical way to purify water. It removes 95-99% of

contaminants contained in the water. In the reverse osmosis process, solutions with different concentrations of contaminants are separated by a semi-permeable membrane. Pressure is applied to the more concentrated side to counteract osmotic pressure. Due to the pressure, pure water flows out of the concentrated solution through the membrane and into its storage tank.

d. On-site PEM Electrolysis

Electrolyzers that utilize a PEM contain a solid-state ion conducting membrane that replaces the liquid electrolyte used in alkaline electrolyzers. The energy inputs to the PEM electrolyzers are comparable to those required by alkaline electrolyzers. But because these units can operate at higher efficiencies, the cost of producing hydrogen is lower. PEM electrolysis is free of toxic materials that can spill or leak and as a result are considered to be a safer alternative than alkaline electrolyzers. While PEM electrolyzers can have a high capital cost, this cost is recouped due to the minimal maintenance costs over their life cycle. Manufacturers typically warrant the key component of the electrolyzers for the life of the unit.

e. Compressors

Due to budget constraints, a reciprocating compressor is suggested for this particular application due to its lower cost in comparison to diaphragm style compressors. Reciprocating compressors are categorized as single, multi stage, and hybrid cycles. Single stage compressors provide an efficient means for moving large amounts of gas when high inlet pressures are available.

The multi-stage compressors increase hydrogen gas from inlet pressures as low as 100 psi to exit pressures as high as 15,000 psi. These units are used to fill storage tanks much like the type that will be used in the HFS team's station. They can be sized to match the flow of hydrogen gas produced by a reformer or electrolyzer. The multi-stage compressor is widely accepted as an economic and reliable component for the compression of hydrogen.

Hybrid compressors combine features of the multi-stage as well as the single stage units. When inlet pressures are low, hybrid compressors behave like a conventional multi-stage unit and will increase inlet gas pressures. When high inlet pressures are obtainable, hybrid machines behave as a single stage compressor and take advantage of the higher capacity that is possible with the higher inlet pressures.

f. Hydrogen Storage

There are numerous methods for storing hydrogen. It can be stored in a liquid state, under high pressure, or through the use of metal hydrides. Storing hydrogen in liquid form allows a larger amount of hydrogen to be stored in a smaller space than either the use of high pressure or metal hydrides. Storage in liquid form requires cryogenic storage. A cryogenic tank consists of inner and outer shells with a vacuum separating them. This vacuum helps prevent heat infiltration from

the outside of the tank. This is important because liquid hydrogen must be stored below its vaporization temperature of -259°C . The extremely low temperature makes this method expensive to employ.

Another method for hydrogen storage is the use of metal hydrides. In this method of storage, hydrogen molecules bond with metal hydride molecules. The metal hydride compound used for hydrogen storage usually consists of sodium, lithium or calcium. Heat is needed to extract the hydrogen from the metal hydride compounds, the heat from a PEM fuel cell can be harnessed for this task. One problem with metal hydride storage is that it can only be stored in small quantities and has slow intake and outtake kinetic properties. This is a concern when selecting a method for hydrogen storage, especially with respect to discharge time.

The last storage method researched is high pressure gas storage. This method stores gaseous hydrogen at a high pressure in a high pressure vessel. The normal pressure range for storing gaseous hydrogen is between 5,000 and 10,000 psi. High pressure hydrogen storage methods are more economically feasible for a small scale refueling stations than the two previous methods. Another advantage of this method is that its charge and discharge times are shorter than other methods. One important factor in determining the charge time is the flow rate of the compressor. The storage tanks are capable of receiving the hydrogen as quickly as the compressor can compress it. A cascade dispensing system is employed with the storage of high pressure gaseous hydrogen. A cascading storage system consists of two or more compressed gas cylinders that are linked in series. For example, a three stage cascading system can be used to store hydrogen at 7,000 psig. The three cylinders in the cascade system would be used to pressurize an empty storage vessel. To accomplish this, the first storage vessel's valve is opened allowing the cascade tank and the tank being filled to equalize in pressure. Both tanks would then have 3,500 psig of hydrogen stored. Next, the valve on the second cylinder in the cascade system would be opened resulting in 7,000 psig to be dispensed into the receiving tank. An example of this process is shown below in Table 2.

Table 2. Pressure Dispersement

	Cascade Fueling System	Automobile Tank
Stage 1	7000 psig	0 psig
	3500 psig	3500 psig
Stage 2	7000 psig	3500 psig
	5250 psig	5250 psig
Stage 3	7000 psig	5250 psig
	6562.5 psig	6562.5 psig

To determine the number of tanks required, the volume of hydrogen at 7,000 psig must be determined. This was accomplished by using a modified ideal gas law.

$$v = \frac{ZRT}{p}$$

The partial pressure of hydrogen is 186 psig. The storage containers will store the hydrogen at 7,000 psig. Because the storage pressure is much greater than the partial pressure of hydrogen, it is not considered an ideal gas. This means that a modified version of the ideal gas law must be used to determine the volume of the hydrogen. The problem with the difference in pressures is solved by introducing the compressibility factor (*Z*) into the ideal gas equation. *Z* is determined using the Nelson-Obert Generalized Compressibility Chart. Below are the calculations used to determine the volume of hydrogen at 7,000 psig, a mass of 10 kg, 296 K, and an ideal gas constant of 4.124 kJ/kg*K. The following equation is used to determine the ratio between the critical and actual pressures. This ratio is used on the Nelson-Obert Chart.

$$P_r = \frac{P}{P_{cr}} = \frac{7000\text{psig}}{188.1\text{psi}} = 37.21$$

Using this value and the generalized compressibility chart the value of the compressibility factor *Z* was determined to be 1.4. The modified ideal gas equation was then employed to solve for the volume of hydrogen stored in the three tank cascade system. The complete computation follows:

$$Z = \frac{Pv}{RT} \longrightarrow v = \frac{ZRT}{p} \longrightarrow v = \frac{1.4 * 4.124 \frac{KJ}{Kg * K} * 296K}{48Mpa} \longrightarrow$$

$$v = 0.036 \frac{m^3}{Kg} \longrightarrow 0.036 \frac{m^3}{Kg} * 10Kg = 0.36m^3$$

These formulas may be used to determine the number of tanks needed in this project's cascading storage system.

g. Dispensing

All hydrogen fueling stations must have a dispensing system to control the flow of hydrogen from the station storage tanks to the vehicle storage tank. Stations that dispense compressed natural gas have found that consumers prefer dispensing systems that are similar to current gasoline/diesel dispensing systems in appearance and operation. In addition, the dispensing nozzle that provides interface between the dispenser and the vehicle must be standardized and thereby compatible with all types of vehicles that will utilize this station for fueling. Standard codes such as NFPA 52 dictate the nozzle rating and thus the final delivery pressure of the dispenser.

The dispensing system will consist of a single unit comprised of the following components:

- Metal dispenser housing (cabinet)
- Leak detection system
- Fill nozzle
- High pressure flexible supply hose
- Flow meter
- User interface and control panel (touch pad and/or LCD)
- Replaceable hydrogen filter
- Break away connection assembly
- Priority sequence panel for implementing a fill algorithm from station cascade storage tanks
- Control system for implementing fill algorithm to account for ambient temperature and heat of compression effects

The specifications for a 350 bar, slow-fill, single hose hydrogen dispenser is a flow meter and display unit like those shown in Table 2. A picture of a dispensing unit is shown in Figure 11.

Table 3. Specification for a Hydrogen Dispensing Unit (Source: Fueling Technologies Inc.)

GENERAL SPECIFICATIONS	
Configuration	Single Hose, 1 Inlet, Side Mounted Nozzle
Maximum working pressure	447 Bar
Maximum flow rate	20 Kg/min
Dimensions	33" W x 22" D x 92" H
Weight	650lbs
Operating Temperature Range	-20° C to 60° C
Electrical Requirements	120 VAC, 3A, 60Hz
External 2 or 3 Bank cascading control output:	Two 110VAC output terminals.
Design codes and standards:	NEC for Class 1 Division 2 Group B ASME B31.3



Figure 11. Hydrogen Dispensing Unit (Source: Fueling Technologies Inc.)

h. Leak Detection

Hydrogen gas leak detection is critical to the safety of the workers, safety response personnel, and customers of the hydrogen fueling station. Since hydrogen is the smallest element in the universe, it is able to pass through many materials and small openings, thus making it extremely dangerous to produce, store, and dispense. The flammability range of hydrogen is very wide with a lower limit of 4 percent. For this reason, detector devices must be capable of detecting amounts of hydrogen down to one percent concentration levels. Two categories of sensors are required. One is a stationary type, which is in continual operation and must be located in any confined space where hydrogen leaks could occur or where hydrogen gas could accumulate; such as the ceiling or air ducts. The second type is a hand-held wand, which is used for daily and/or periodic inspections by the station superintendent.

Five types of sensors were researched. Catalytic bead sensors use two beads connected to a Wheatstone bridge. One bead is coated to act as the catalyst and the other is passive. When hydrogen gas is present, a difference in resistance between the two beads causes a change in current flow through the galvanometer. This variation of signal then results in the galvanometer outputting a signal to a warning device. The catalytic bead sensor was not chosen because it does not react only to hydrogen. This could result in false alarms.

A second type of sensor is an electro-chemical sensor. This operates on the principle that when hydrogen gas passes over the chemically sensitive electrolyte, a reversible chemical reaction occurs. This reaction generates a current proportional to the gas concentration. When there is no longer gas present, the

electrolyte returns to its original state. This type of sensor was not chosen because it is not hydrogen specific.

A third type to be considered is the hydrogen field-effect transistor. This sensor uses palladium as its gate material. The presence of hydrogen gas causes small changes in the palladium, which produces large changes in the current-voltage characteristic of the transistor. The transistor then outputs a signal to a warning system. This type of sensor meets the requirements of safety parameters.

A fourth type was the solid state sensor. This sensor uses semiconducting oxides to detect the amount of oxygen in the air. The presence of hydrogen reduces the amount of oxygen and results in the sensor sending a signal to a warning indicator.

The final type researched was the resistive palladium alloy. This sensor utilizes the ability of palladium to dissolve more than six hundred times its volume in hydrogen. The amount dissolved proportionally changes the resistivity of the metal and results in the sensor sending a signal to a warning indicator.

The selected hand-held wand sensor is a solid state sensor. It meets and/or exceeds all safety requirements pertaining to hydrogen detection. The stationary sensor selected is a hybrid between solid state and palladium sensors. It uses palladium to detect leaks, but uses the solid state electronics to operate.

i. Site Location

Four possible sites were considered for the hydrogen station location. The University of Tennessee at Chattanooga Advanced Vehicle Testing Facility (UTC AVTF) (Figures 12 & 13) located off Amnicola Highway near Highway 153 was selected as a prime location, since both the shuttle bus as well as the Saturn Vue will be tested there. The site also has a large building already on site that can accommodate the hydrogen fuel station in its entirety. The AVTF is also an isolated location, so in the event of an accident, spills, and/or fires could be contained with minimal threat to the public.



Figure 12. CETE Advanced Vehicle Test Facility Building



Figure 13. CETE Advanced Vehicle Test Facility Track

The CARTA Electric Bus Facility located on Market Street next to the Chattanooga Choo Choo Hotel (Figure 14) is another possible location for the hydrogen fuel station. This site allows easy access for shuttle buses should the CARTA bus line decide to convert their busses to run on hydrogen. The close proximity to the public and other combustible materials may increase facility costs in regards to ISO and NFPA location standards. The major draw back to this location is its inaccessibility to the AVTF, were the shuttle bus and Saturn Vue will be tested.



Figure 14. CARTA Electric Bus Facility

The UTC SIM Center (Figure 15) is another possibility for the fueling station. The building located behind the SIM center would be an ideal location due to its close proximity to UTC. This facility also has a solid state fuel cell in place, which means UTC has experience in meeting all local fire codes and safety requirements pertaining to hydrogen production and storage.

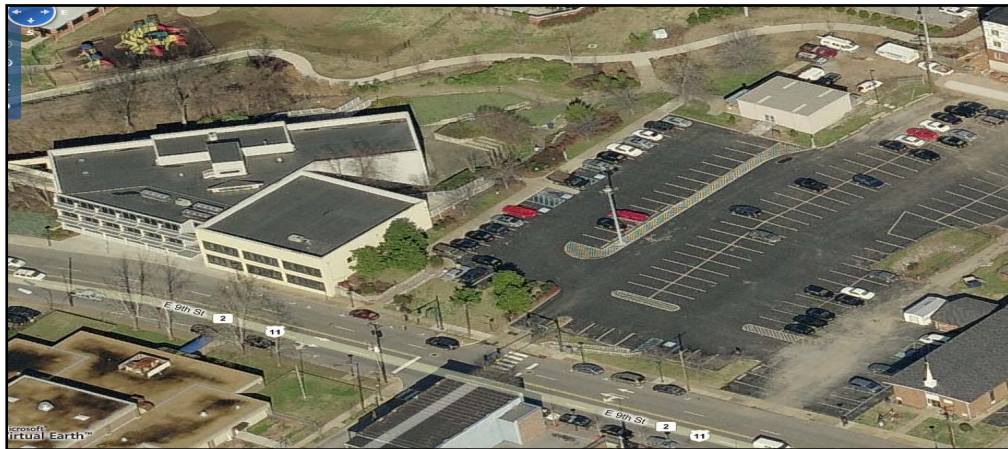

Figure 15. UTC SIM Center

UTC Parking Services (Figure 11) is the last location to be looked at. This location provides a great opportunity for UTC's engineering department. Being across from the engineering math and computer science building (EMCS) visitors and guests of the engineering department could simply walk over and visit the facility. This would provide great opportunities for individuals and businesses that fund programs such as UTC's interdisciplinary design projects.



Figure 16. UTC Parking Facilities Site

The optimal location for the hydrogen fueling station was determined by using the decision matrix in figure 10. Each of the four prospected locations was graded against the six traits that are important aspects for the location of the fueling station. The UTC Advanced Vehicle Testing Facility showed an overwhelming advantage over the other three locations. This is greatly due to the Saturn Vue, which will use the hydrogen produced by the fueling station to perform road test at the UTC AVTF.

Table 4. Location Matrix

TRAIT	WEIGHT FACTOR	LOCATIONS			
		UTC AVTF	SIM CENTER	BUS DEPOT	UTC PARKING FACILITY
Solar Energy Availability	5	5	0	0	0
Restrictions of Saturn Vue	50	50	0	0	0
Secure Area	10	10	9	5	7
Accessibility from Campus	5	0	5	0	5
Explosion Hazard	10	10	0	0	5
Controlled Testing Environment	20	20	0	0	0
TOTAL	100	95	14	5	17

Within the UTC AVTF there are four locations that are projected for the fueling station. Figure 17 is a CAD rendering of the test track facility, this figure depicts the four locations that are prospects for the fueling station location within the UTC AVTF.

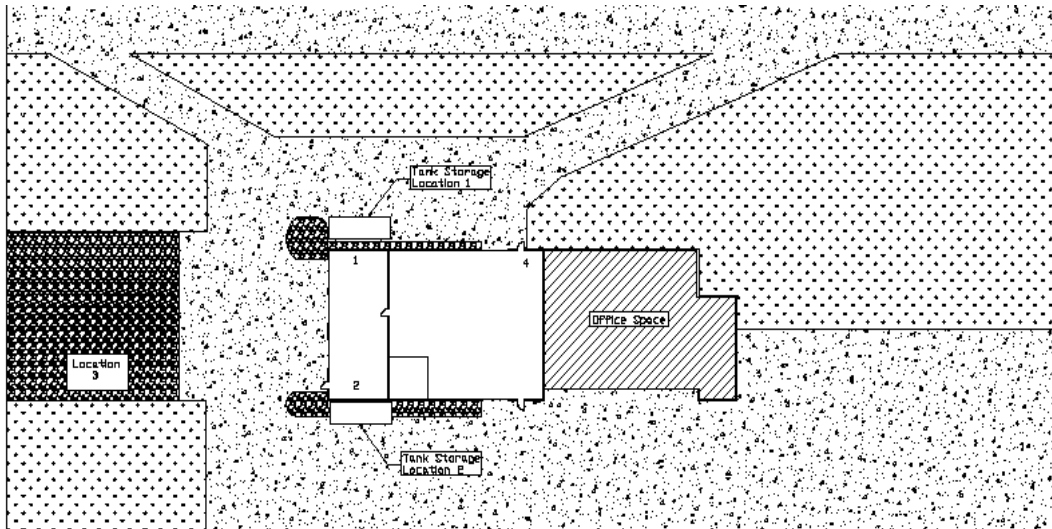

Figure 17. AVTF Drawing

A decision matrix was drafted to determine the optimal location within the UTC AVTF. Location 1 and 2 are in the same bay and offer superior ventilation. Both location 1 and 2 have available electric power. Location 3 is located outside of the building in a fenced in gravel lot. This location will require that a building with a concrete pad be built. Location 3 has electric power available, but it has no water hook up. Location 4 is sited within the main bay of the existing building and this location has available electric power and water. The only problem with Location 4 is that there are two bay doors and a walk-through door in this corner of the building which could present obstacles to using this area for the electrolyzer and water purification system

Table 5. AVTF Location Metrics

TRAIT	WEIGHT FACTOR	LOCATIONS			
		1	2	3	4
Volume of Air for Ventilation	10	10	8	10	10
Indoor Location for Electrolyzer	20	20	20	5	20
Ease of Fueling Test Vehicle	20	20	16	16	20
Safety/Prohibit Unauthorized Entry	20	20	20	8	10
Proximity to Solar Panels	10	10	10	0	4
Access to Water and Electricity	20	15	20	8	20
TOTAL	100	95	94	47	84

Conclusions drawn from the decision matrix led the team to choose Location 1 within the UTC AVTF. Location 1 is located in an area with more than adequate ventilation to meet the safety requirements of gaseous hydrogen along with the

fact that all necessary water and electric sources are readily available. All 4 locations meet the site preparation requirements for installation of a Hogen 40 electrolyzer which requires that a concert slab be installed such that the slab is no more than 2 degrees from level. If a more suitable location within the AVTF is identified, some minor modifications may be necessary to assure a trouble free installation such as rerouting of water and electrical sources to the electrolyzer.

j. Value Engineering and Analysis

At some point during the design phase, it is beneficial to perform a value analysis, or value engineering (VE) study, on individual components to determine if cost can be reduced or if quality can be improved. To determine if any improvements could made in this regard, a rudimentary value analysis was conducted for the major components of the refueling station. The first step was to make a list of functions performed by the refueling station. Next, this list was broken down into basic functions and secondary functions. Basic functions define the reason for the product or design. In this case, the principle reason for the hydrogen refueling station is to make and dispense hydrogen for vehicle use. Secondary functions are typically the methods by which these basic functions are brought to fruition, or those functions that support the basic functions. Again, in the case of the hydrogen refueling station, secondary functions might include regulating hydrogen flow or detecting leaks. Table 6 shows a succinct, but not comprehensive, list of functions performed by the hydrogen refueling station.

Table 6. Function Analysis for Refueling Station

Function#	Verb	Noun	Basic	Secondary
1	compress	hydrogen	X	
2	generate	hydrogen	X	
3	regulate	flow		X
4	prevent	leaks		X
5	transfer	hydrogen		X
6	warns	user		X
7	filter	water		X
8	contain	hydrogen		X
9	allow	flow		X
10	measure	flow		X
11	fill	tanks		X
12	supply	hydrogen	X	X
13	supply	water		X
14	increase	convenience		X
15	control	flow		X

Once the basic and secondary functions were delineated, a cost-function matrix was created for the components related to the basic functions only. The cost-function matrix for the components that perform basic functions is shown in Table 7. The components making up the secondary functions were considered to have little overall impact on product price and quality. This is true since most of these components, which consist mostly of piping, control valves, pressure regulators,

pressure relief devices, and fittings, have single vendors, comprise a very small portion of overall cost, and meet or exceed current industry standards for safety and performance.

Table 7. Cost-Function Matrix for Major Components

Components	Cost (in \$1000)	Compress Hydrogen		Generate Hydrogen		Supply Hydrogen			
		%	Cost	%	Cost	%	Cost		
Hydrogen Refueling Station									
Electrolyzer	79			100%	79				
Compressor	95	100%	95						
Storage Tanks	19	33%	6.3	33%	6.3	33%	6.3		
Dispensing System	48					100%	48		
Total Function Cost	241	42%	101.3	35%	85.3	23%	54.3		

From Table 7, it can be seen that the biggest impact on value could be achieved with respect to the generation and compression functions of the station design. As a result, the only these two components were studied in detail.

For hydrogen generation, three different methods were considered for the final design. While potentially less expensive up front, the steam methane reformers and alkaline electrolyzers held hidden costs that diminished their value in the design. With respect to the former, the unstable price of natural gas held great potential for vast operating cost swings. With respect to the latter, frequent maintenance and hazardous chemical monitoring/handling presented increased operating costs and lowered reliability. As result, it was determined that a PEM electrolyzer, while more expensive up front, lowered operating costs and increased reliability, therefore substantiating its superior value.

For the compression function, two types of compressors were considered. Quotes for a reciprocating piston type and for a three-diaphragm type compressor were obtained. While the diaphragm type compressors are four times the cost of a comparable piston type, issues with reliability and with product contamination must be considered in an effort to establish a relative value. The piston type compressors are noted for their relative unreliability and for contamination of the hydrogen stream with hydraulic fluid. On the other hand, for pure hydrogen production, the diaphragm type compressors are preferred for ensuring a contaminant free hydrogen stream. When considering potential costs that could result from impure hydrogen delivered to a customer, especially with a fuel cell vehicle, it was determined that a diaphragm type compressor held superior value over the piston type. A further note is that the diaphragm type compressors are better suited to the small scale hydrogen production of PEM electrolyzer chosen for the design. Specifically, the electrolyzer chosen had an impact on the final

choice of a compressor. It is worthy to also note that using a diaphragm type compressor precludes the necessity of a buffer tank, which would have been required if a piston type compressor had been chosen.

Finally, the value analysis performed for this project was rudimentary due to the absence of a complete, concise, and definite final design. Final drawings showing elaborate detail and indicating every single component for an actual design were not part of the scope of this project. However, the principles of value analysis were helpful in determining not only major components, but also in looking at alternative designs. For instance, it was considered feasible from the beginning of the project that a suitable alternative to onsite production might be a portable tube trailer delivered to the refueling station site. While a dispensing system would still be required, a tube trailer would negate the need for the generation and compression function. Other studies have indicated that this is the lowest cost option for refueling a small fleet of vehicles.¹⁴ However, the tube trailer option does not lend itself to refueling large vehicle fleets or to showing the viability and reliability of distributed hydrogen generation, which is considered to be a necessary part of the hydrogen economy. For hydrogen to be a suitable alternative to current transportation fuels, it must be available at every street corner, as gasoline is currently. The most cost effective option for prevalent hydrogen refueling facilities is local, distributed generation and compression.

k. Testing Requirements and Procedures

Several assumptions were made to estimate the amount of energy required to produce and compress the required amounts of hydrogen needed. Once installed the system efficiency can be determined using installed electrical meters.

At the UTC Hydrogen Fueling Station, safety has the highest priority. This means that any action that can present an unsafe situation is prohibited. The dangers associated with hydrogen are very real and must be considered at all times. First, it is important to understand what these dangers are. Hydrogen is a flammable and explosive gas. It requires a very low amount of energy to ignite (one tenth the amount of energy required to ignite gasoline) and it burns with an invisible flame. What all this means is that extra care must be taken to eliminate any possibility of a fire. Hydrogen, like all gases can displace oxygen and cause asphyxiation. This event is unlikely; however, it must be considered when inside the building. If a hydrogen leak is detected inside, safe practice is to open the doors and windows, exit the building, and let trained personnel handle the equipment.

The number one cause of accidents is human error. Therefore, every effort must be made to eliminate the potential for accidents due to human errors. The installation of clearly visible safety signs will reduce the risk of a fire or any other

¹⁴ Weinert, Jonathan. [A Near-Term Economic Analysis of Hydrogen Fueling Stations](#). Tech. no. UCD-ITS-RR-05-04. University of California - Davis, Institute for Transportation Studies, 2005.

accident. Smoking is not allowed near any of the fueling station equipment, and signs should clearly indicate this prohibition.

The UTC Hydrogen Fueling Station is not designed for public use. This means it should not be operated by anyone other than an individual who has been trained to operate this equipment. No one shall touch the equipment or fuel a vehicle without first being properly trained on the UTC Hydrogen Fueling Station.

I. Safety and Standards

In order to maintain the safety of those who use the hydrogen fueling station, it is of paramount importance that all applicable rules and regulations are followed. These rules and regulations may be based on criteria set forth by national government agencies, such as the U.S. Department of Occupational Safety and Health Administration (OSHA), as well as state and local permitting agencies. Many organizations have recently added amendments specific to the topic of hydrogen gas used as a fuel source that is distributed to the general public.¹⁵

There are several organizations that have rules or regulations pertinent to different aspects of the project's completion. These organizations are listed below as related to the step in construction that they are applicable to.

i. General Design

International Fire Code (International Code Council)

35- Flammable Gases

2209.1 -General

NFPA 30A, Code for Motor Fuel Dispensing Facilities and Repair Garages

7.3 -Motor Fuel Dispensing Facilities

NFPA 52, Vehicular Fuel Systems Code

9.3 -System Siting

14.2 -Facility Design

NFPA 55, Use and handling of compressed gases and cryogenic fluids

7.1.6 Separation from Hazardous Conditions

An example of the NFPA 55 10.4.4 Indoor Hydrogen System Location is outlined below:

Hydrogen systems of less than 3500 scf (99m³) and greater than the MAQ, where located inside buildings shall be located in the building so the system will be as follows:

- 1) In a ventilated area in accordance with the provisions of section 6.16

¹⁵ Lenntech. "Hydrogen-H." Chemical properties of hydrogen - Health effects of hydrogen - Environmental effects of hydrogen. 2008. Lenntech Water treatment & air purification Holding B.V. Sept.-Oct. 2008 <<http://http://www.lenntech.com/periodic-chart-elements/h-en.htm>>.

- 2) Separated from incompatible materials in accordance with the provisions of 7.1.6.1.
- 3) 25 ft (7.6m) from open flames and other sources of ignition.
- 4) 50 ft (15m) from intakes of ventilation, air-condition equipment, and air compressors.
 - a. The distance is permitted to be reduced to 10 ft (3m) where the room or area is protected by a listed detection system as per article 500.7 (K) of NFPA70, National Electrical Code, and the detection system shall shut down the fuel supply in the event of a leak that results in a concentrations that exceeds 25 % of the LFL.
 - b. Isolation values used to isolate the fuel supply shall be of a fail-safe design.
- 5) 50 ft (15m) from other flammable gas storage.
- 6) Protected against damage in accordance with the provisions of 7.1.6.6

ii. Equipment

International Fire Code (International Code Council)
2209.2 Equipment

NFPA 52, Vehicular Fuel Systems Code
9.2 General System Requirements

iii. Barrier Walls

International Fire Code (International Code Council)
2209.3.1.1 Barrier Wall Construction – Gaseous Hydrogen

NFPA 55, Standard for Storage, Compressed Gases and Cryogenic Liquids

8.6.2.1 Fire Barriers
8.6.3.1 Fire Barriers

iv. Weather Protection

International Fire Code (International Code Council)
2209.3.2.2 Weather Protection
2704.13 Weather Protection

v. **On-Site Production**

- International Fire Code (International Code Council)
 - 2209.3.1 Separation from Outdoor Exposure Hazards
- International Fire Code (International Code Council)
 - 703.1 General Requirements
- NFPA 52
 - 5.2 Systems Approvals

m. **Hydrogen Safety**

Hydrogen is an odorless, colorless and tasteless gas 15 times lighter than oxygen. A hydrogen leak in an open air fueling station poses a low threat to those around it. In enclosed spaces, high concentrations of hydrogen may be reached quickly should a leak develop. The high concentration of hydrogen could cause a deficiency of oxygen, possibly resulting in individuals exposed to the hydrogen experiencing “headaches, ringing ears, dizziness, drowsiness, unconsciousness, nausea, vomiting and the depression of all the senses. The skin of the victim may have a blue color. Under some circumstances death may occur. Hydrogen is not expected to cause mutagenicity, embryotoxicity, teratogenicity or reproductive toxicity. Pre-existing respiratory conditions may be aggravated by overexposure to hydrogen.¹⁶ Still, the chance of a hydrogen leak in a properly designed and maintained system is small. Despite the relatively low molecular size of hydrogen compared to other fuels, properly mated metal-to-metal seals (flared or compression joints) are considered sufficient.

Hydrogen has the widest range of flammable concentrations in air among all common gaseous fuels. Hydrogen’s lower and upper concentration limits, 4% and 75% by volume, give it a large range of flammable volumes. Other properties of the gas, such as its high buoyancy and high diffusivity tend to cause a decrease in the ignition potential over time. Hydrogen also has a low auto ignition temperature, which can cause ignition by heating or spark. The minimum spark energy required is approximately one tenth of that required by gasoline, and like gasoline exposure to weak sparks, hot surfaces or open flames are sufficient to ignite hydrogen. Even a small leak could be very hazardous, because despite having a higher flame temperature than hydrocarbon fires, such as natural gas, coal, or petroleum derivatives, it burns nearly invisible. “The energy of an explosion of hydrogen, expressed in kg of TNT per kg fuel is 24, compared to 11 for methane and 10 for gasoline.”¹⁷ ¹⁸ Continuous exposure to hydrogen also causes embrittlement in some steels. This may cause cracks in pipes, welds, and

¹⁶ Weinert, Jonathan. A Near-Term Economic Analysis of Hydrogen Fueling Stations. Tech. no. UCD-ITS-RR-05-04. University of California - Davis, Institute for Transportation Studies, 2005.

¹⁷ Lenntech. "Hydrogen-H." Chemical properties of hydrogen - Health effects of hydrogen, Environmental effects of hydrogen. 2008. Lenntech Water treatment & air purification Holding B.V. Sept.-Oct. 2008 <<http://www.lenntech.com/periodic-chart-elements/h-en.htm>>.

¹⁸ Praxair Material Safety Data Sheet. Tech. No. P-4604-G. Material Safety, Praxair Technology Inc. Praxair Technology Inc. 1-10.

metal gaskets. In general, stainless steel has better embrittlement resistance properties than other steels, and aluminum and its alloys are considered better than stainless steels, providing the gas is dry.¹⁹

n. Budget Analysis

Economic analysis is a major constituent of the final design phase. As the design goes from concept to realization an economic assessment must accompany. The analysis examines capital costs and operating costs, providing a total annual cost of the Hydrogen Production facility. This cost figure, divided by the yearly production of hydrogen, gives a cost per kilogram for the system.

Capital costs consist of equipment purchases, and training, as well as site preparation and set up. The total capital cost of \$214,000.00 is established from a bid from Proton Energy, a copy of bid is located in appendix. The bid includes a fueling nozzle, a fueling tank and a HP tank consisting of 10 DOT3AA6000 Cylinders. Next on the bid list is a water purifier by Aqua Solutions which will feed into the Hogen 40 electrolyzer which has a 2.27 kg per day production capacity. The hydrogen will be carried to diaphragm compressor capable of compressing hydrogen up to 6000psi. A calibration kit and diagnostic software are also included in the bid. Ordinarily site purchase fees would be located in the capital cost sections, but this facility has the advantage of a free site location.

In order to assess capital costs into the cost per kilogram of hydrogen produced, the capital costs must be annualized. For the sake of this analysis an interest rate of 8% is assumed, and a payback period of ten years was chosen. The formula for annualizing present worth is found below.

$$A = P \left(\frac{i(1+i)^n}{(1+i)^n - 1} \right)$$
$$A = 220,414 \left(\frac{0.08(1+0.08)^{10}}{(1+0.08)^{10} - 1} \right)$$

$$A = \$38,274.26$$

In the above formula, *A* is annualized worth over the payback period, *n*. The interest rate, *i*, is then plugged into the equation. In the economic analysis of the Hydrogen Production facility \$220,414.00 was used as a capital cost which includes training and set up. A pay back of ten years was chosen and an interest rate of 8% assumed providing a figure of \$38,274.26.

The next step in the economic analysis is to establish operating costs. Once a bid had been obtained with a component list utility duties could be established. The

¹⁹ Ibid

Aqua Source water purifier uses 0.94 liter per hour. 24 hour operation time is assumed with no downtime for maintenance. The total water use per month is 24ft³ establishing a water rate of \$0.20/ft³. This is added to a ¾” meter fee which costs \$18.28 per month for a total water bill of \$23.08 per month. A ¾” meter was chosen because it is same size as inlet diameter of water purifier.

Electricity needs are the next step in establishing operating costs. The Hogen 40 electrolyzer uses 169kWh to produce the 2.27kg it make during 24 hour operation. Multiplying this energy usage by a \$0.09/kWh residential utility rate gives a daily cost of \$15.58. A compressor duty of 8kWh per day is assumed based on interpretation of Chart EA1 located in appendix.

The total operating costs per year are calculated to be \$6,248.00. This is added to the annualized capital cost for a total yearly cost \$44,500. Divide this by the yearly production rate, excluding downtime for maintenance, of 828 kg of hydrogen gives a cost of \$53.77 per kilogram of hydrogen. If capital costs are ignored, a rate of \$8.00 per kilogram is found. It is apparent that much work needs to be done in order for electrolysis to be an economically viable method of hydrogen production, with the capital cost being the single largest hurdle. This is due primarily to the relatively low number of systems built each year as reflected in an installed base of less than 100. An Excel model (H2 Spreadsheet) for this analysis is provided in the Appendix. I. However, for research purposes, the electrolysis based system will meet the basic requirements while staying within the budget constraints of this cooperative agreement.

o. Environmental Issues

One of the benefits of hydrogen fuel is the reduction of greenhouse emissions. Greenhouse gases trap heat waves that are reflected by the earth and contribute to global warming. Greenhouse gases include water vapor, carbon dioxide, methane, nitrous oxides, ozone and CFC's.²⁰

Hydrogen as a fuel produces virtually no emissions. When pure hydrogen is fed into a fuel cell vehicle, the only by-product is water vapor.

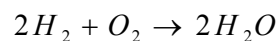

In a combustion engine, small amounts of nitrogen oxides can be produced, as well due to the high temperature of the reaction. Comparing the performance of hydrogen and diesel fuel can be problematic because hydrogen is a gas at room temperature. For this reason, comparisons are often made based on energy

²⁰ “Petroleum Basic Statistics.” Energy Information Administration. Sept. 2008. U.S. Department of Energy. 14 Oct. 2008 <http://www.eia.doe.gov/basics/quickoil.html>.

equivalence. A gallon of diesel fuel and a kilogram of hydrogen both contain approximately 120 mega Joules of energy.²¹ While carbon dioxide is not directly produced by hydrogen vehicles, some carbon dioxide is emitted in the production of the hydrogen. The values in Table 8 do not take into account any carbon capture or sequestration.

Table 8. Carbon Dioxide Emissions for Various Hydrogen Production Methods

Production Method	kg CO ₂ /kg H ₂
Coal Gasification	19
Natural Gas Reforming	17.6
Electrolysis – Non-Renewable Power Source	12
Electrolysis – Renewable Power Source	0

In order to determine the amount of carbon dioxide emitted by today’s internal combustion engine, it is assumed that diesel fuel is mostly octane and that complete combustion occurs. The combustion equation is as follows:

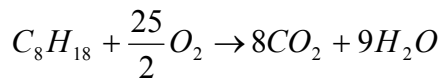

Using this equation, the amount of carbon dioxide emitted per gallon of diesel fuel can be calculated.

$$1gal_{gas} * \left(\frac{2.661kg_{gas}}{gal_{gas}}\right) * \left(\frac{kmol_{gas}}{114kg_{gas}}\right) * \left(\frac{8kmol_{CO_2}}{kmol_{gas}}\right) * \left(\frac{44kg_{CO_2}}{kmol_{CO_2}}\right) = 8.2kg_{CO_2}$$

The amount of carbon dioxide emitted from a diesel engine may seem to be less than that emitted in the production of hydrogen, but it is important to remember that hydrogen is more efficient than gasoline. Also, when carbon capture methods are used in the production of hydrogen, the values seen in Table 3 can be drastically reduced. The ideal production method would be electrolysis using renewable energy sources because it would completely eliminate carbon dioxide emissions.

²¹ "Lower and Higher Heating Values of Fuels." Hydrogen Analysis Resource Center. Mar. 2006. US Department of Energy. 14 Oct. 2008, http://hydrogen.pnl.gov/cocoon/morf/hydrogen/site_specific/fuel_heating_calculator?canprint=false

From stoichiometric analysis, the amount of water vapor emitted from a kilogram of hydrogen fuel can be calculated.

$$1\text{kg}_{H_2} * \left(\frac{\text{kmol}_{H_2}}{2\text{kg}_{H_2}}\right) * \left(\frac{2\text{kmol}_{H_2O}}{2\text{kmol}_{H_2}}\right) * \left(\frac{18\text{kg}_{H_2O}}{\text{kmol}_{H_2O}}\right) = 9\text{kg}_{H_2O}$$

In an internal combustion engine, the water vapor emitted can be calculated as follows:

$$1\text{gal}_{gas} * \left(\frac{2.661\text{kg}_{gas}}{\text{gal}_{gas}}\right) * \left(\frac{\text{kmol}_{gas}}{114\text{kg}_{gas}}\right) * \left(\frac{9\text{kmol}_{H_2O}}{\text{kmol}_{gas}}\right) * \left(\frac{18\text{kg}_{H_2O}}{\text{kmol}_{H_2O}}\right) = 3.8\text{kg}_{H_2O}$$

It is important to remember that hydrogen is more efficient than diesel fuel; therefore, the amount of water emitted by both is approximately equivalent on a per mile basis.

Also important to consider is that hydrogen leaked to the atmosphere is detrimental to the environment. It is estimated that approximately 10-20% of all hydrogen produced for transportation will be leaked at some point during production, storage or distribution.²² This is an environmental hazard because of hydrogen's wide flammability range and low ignition temperature. The hydrogen and air mixture can be easily ignited. Alternatively, the hydrogen can rise up to the upper atmosphere where it will get oxidized into water. This would cause a cooling effect, which could have an impact on ozone chemistry.²³

²² Tracey, Tromp K. "Potential Environmental Impacts of a Hydrogen Economy on the Stratosphere." Science Magazine. <http://www.sciencemag.org/cgi/content/full/300/5626/1740>.

²³ Ibid

IV. CONCLUSION

The requirement to design and build a station that is capable of producing 2 kg of hydrogen day while storing 10 kg has been met. The major components for the hydrogen fuel station have been acquired by CETE and system integration is underway, with a goal to have the fueling station commissioned by the end of October 2009. This hydrogen fueling station will be a critical element in the overall East Tennessee Hydrogen Initiative and contribute to further hydrogen research as CETE develops a hydrogen hybrid transit vehicle under FTA Cooperative Agreement TN-26-7034.

During the early stages of this research project, CETE was focused on evaluating reforming ethanol into hydrogen primarily due to the high cost of oil and the prospects for producing ethanol from plant materials such as switch grass in Tennessee. This process is dependent upon being able to scale up by orders of magnitude the basic biological processes that have been demonstrated in the laboratory, but it turns out that this is neither easy nor quick. The theoretical yield from this process continues to look promising, but much remains to be done before significant production of ethanol from cellulose will occur. As a result, CETE revised its research approach from analyzing the “photon to wheel” efficiency from reforming ethanol to generate hydrogen and energy efficiency of ethanol as a direct fuel for the internal combustion engine efficiency to concentrate on analyzing generation of hydrogen from electrolysis. This new direction allowed CETE to learn enough about the process of reformation of ethanol to conclude that its research efforts in going forward need to focus on production of hydrogen from water and electricity using electrolysis. The small hydrogen generation, storage and dispensing station that CETE is developing will provide a research platform to explore hydrogen generation while also supporting an immediate need for fuel to supply the hybrid shuttle bus being developed under TN-26-7034. Finally, it will also give CETE hands-on experience that may lead to ideas for reducing the cost of ethanol production equipment which will be a requirement before the hydrogen economy can become a reality.

In summary, the research conducted by CETE under FTA Cooperative Agreement TN-26-7032 has resulted in the design and development of a hydrogen fueling station. This end result was based on a comprehensive analysis of various methods for producing hydrogen including nuclear energy, coal gasification, natural gas reformation and electrolysis. The simulation model developed during the research project to relate energy consumption to power and energy storage requirements for public transportation vehicle operations provided data to connect this research with CETE’s development of the hydrogen hybrid transit vehicle under TN-26-7034. The engineering and technical analyses completed during this research project were complemented by the development of economic models used to estimate the cost of hydrogen production by electrolysis compared to large scale production costs associated with coal gasification and natural gas reformation. This report also includes a description of a rigorous decision making process that was used to select the various technologies used in the final configuration of a hydrogen fueling system that was optimized to support research on the use of hydrogen for transit vehicle operations. The research under this FTA Cooperative Agreement has led to the design and implementation of a system for generating, compressing, storing and dispensing hydrogen in sufficient quantities to support testing of hydrogen fueled transit vehicles.

REFERENCES

- A. International Organization for Standardization (ISO), ISO 15869, Gaseous Hydrogen and Hydrogen Blends – Land Vehicle Fuel Tanks.
- B. International Organization for Standardization (ISO), ISO 14687, Hydrogen Fuel – Product Specification.
- C. International Organization for Standardization (ISO), ISO 15916, Basic Considerations for the Safety of Hydrogen Systems
- D. International Organization for Standardization (ISO), ISO 23273, Fuel Cell Road Vehicles – Safety Specifications –Part 2: Protection Against Hydrogen Hazards for Vehicles Fuelled with Compressed Hydrogen.
- E. International Organization for Standardization (ISO), ISO 11114, Transportable Gas Cylinders – Compatibility of Cylinder and Valve Materials with Gas Contents – Part 4: Test Methods for Selecting Metallic Materials Resistant to Hydrogen Embrittlement.
- F. International Organization for Standardization (ISO), ISO 13984, Liquid Hydrogen – Land Vehicle Fuelling System Interface.
- G. International Organization for Standardization (ISO), ISO 13985, Liquid Hydrogen – Land Vehicle Fuel Tanks.
- H. International Organization for Standardization (ISO), ISO 16111, Transportable Gas Storage Devices – Hydrogen Absorbed in Reversible Metal Hydride.
- I. International Organization for Standardization (ISO), ISO 17268, Compressed Hydrogen Surface Vehicle Refueling Connection Devices.
- J. National Fire Protection Association (NFPA) Code for Motor Fuel Dispensing Facilities and Repair § 1, 2, 3, 6, 7, 8, 9, 12 *et seq.* 2008.
- K. National Fire Protection Association (NFPA) 52 Vehicular Fuel Systems Code, § 1, 2, 3, 5, 7, 9 *et seq.* 2006.
- L. National Fire Protection Association (NFPA) 55 Standard for the Storage, Use, and Handling of Compressed Gases and Cryogenic Fluids in Portable and Stationary Containers, Cylinders, and Tanks, § 1, 2, 3, 4, 5, 6, 7, 10 *et seq.* 2005.
- M. “Daily Fuel Gauge Report.” AAA's Media Site for Retail Gas Prices. 14 Oct. 2008. AAA. 14 Oct. 2008 <http://www.fuelgaugereport.com/tnavg.asp>.
- N. “Petroleum Basic Statistics.” Energy Information Administration. Sept. 2008. U.S. Department of Energy. 14 Oct. 2008 <http://www.eia.doe.gov/basics/quickoil.html>.

- O. "President's Hydrogen Fuel Initiative: A Clean and Secure Energy Future." U.S. Department of Energy Hydrogen Program. 2003. U.S. Department of Energy. 14 Oct. 2008 http://www.hydrogen.energy.gov/presidents_initiative.html.
- P. "Hydrogen and Fuel Cells Research." National Renewable Energy Laboratory: Science and Technology. 2 Sept. 2008. NREL. 14 Oct. 2008 <http://www.nrel.gov/hydrogen/>.
- Q. "Hydrogen Fueling Station Database." National Hydrogen Association: General Information. 14 Oct. 2008. NHA. 14 Oct. 2008, <http://www.hydrogenassociation.org/general/fuelingsearch.asp>
- R. "Hydrogen Road Tour '08." 31 States in 18 Cities in 13 Days. 2008. U.S. Department of Transportation (US DOT). 14 Oct. 2008 <http://hydrogenroadtour08.dot.gov/>.
- S. National Research Council (U.S.). "Hydrogen Production Technologies." The Hydrogen Economy: Opportunities, Barriers, and R&D Needs. New York: National Academies P, 2004. 91-105.
- T. Besenbruch, G.E. "High Efficiency Generation of Hydrogen." OECD/NEA, Information Exchange Meeting on the Nuclear Production of Hydrogen, 2 Oct. 2000, Paris, France. 14 Oct. 2008 <http://web.gat.com/pubs-ext/misconf00/a23510.pdf>.
- U. "Gasification Technology R&D." U.S. Department of Energy. 10 Sept. 2008. U.S. Department of Energy. 14 Oct. 2008 <http://fossil.energy.gov/programs/powersystems/gasification/index.html>.
- V. Canine, Craig. "How to Clean Coal." OnEarth. Fall 2005. Natural Resources Defense Council. 14 Oct. 2008 <http://www.nrdc.org/onearth/05fal/coal1.asp>.
- W. Hydrogen Production " Steam Methane Reforming (SMR)." HYDROGEN FACT SHEET. New York State Energy Research and Development Authority. 14 Oct. 2008 <http://www.getenergysmart.org/files/hydrogeneducation/6hydrogenproductionsteammethanereforming.pdf>.
- X. "Today's Hydrogen Production Industry." U.S. Department of Energy Hydrogen Production Technology. 28 Oct. 2005. U.S. Department of Energy. 14 Oct. 2008 <http://www.fossil.energy.gov/programs/fuels/hydrogen/currenttechnology.html>.
- Y. A Look At Some Of The More Promising Alternative Fuels." 2005. Natural Gas Liquid. 14 Oct. 2008 <http://www.naturalgasliquid.com/>.
- Z. Tracey, Tromp K. "Potential Environmental Impacts of a Hydrogen Economy on the Stratosphere." Science Magazine. <http://www.sciencemag.org/cgi/content/full/300/5626/1740>.

- AA. "Lower and Higher Heating Values of Fuels." Hydrogen Analysis Resource Center. Mar. 2006. US Department of Energy. 14 Oct. 2008
http://hydrogen.pnl.gov/cocoon/morf/hydrogen/site_specific/fuel_heating_calculator?can_print=false.
- BB. Lenntech. "Hydrogen-H." Chemical properties of hydrogen - Health effects of hydrogen - Environmental effects of hydrogen. 2008. Lenntech Water treatment & air purification Holding B.V. Sept.-Oct. 2008 <<http://http://www.lenntech.com/periodic-chart-elements/h-en.htm>>.
- CC. Praxair Material Safety Data Sheet. Tech. No. P-4604-G. Material Safety, Praxair Technology Inc. Praxair Technology Inc. 1-10.
- DD. National Renewable Energy Laboratory, "Technology Brief: Analysis of Current-Day Commercial Electrolyzers," NREL/FS-560-36705, September 2004.
- EE. Department of Energy Multi-Year Research, Development, and Demonstration Plan, Section 3.1.4.2.4 "Hydrogen Generation by Water Electrolysis Barriers."
- FF. Standard temperature and pressure (STP) is 0C & 1 atm; Normal temperature and pressure (NTP) is 20 C & 1 atm; At NTP 1 mole of ideal gas volume = 22.4L or 0.0224Nm³, 1 mole of H₂ = 2 g of H₂, 1 Nm³ of H₂ = 0.0892kg.
- GG. H₂ Safety Best Practices" H₂ Best Practices, Pacific Northwest National Laboratory and Los Alamos National Laboratory, September 2008
http://h2bestpractices.org/storage/compressed_gas/fittings_and_joints/
- HH. "Fuel Cell Sensors and Overview," HIL Tech Development Limited, March 2005
http://www.hiltechdevelopments.com/images/uploads/fuel_sensors.pdf
- II. "Hydrogen Safety," Hydrogen Association, Fact Sheet Series Number 1.008, No Date Given. http://www.hydrogenassociation.org/general/factSheet_safety.

APPENDIX A-Hydrogen Production Cost Model

Hydrogen Production Facility

University of Tennessee at Chattanooga
485 Spring 2009

Water Needs Hogen 40 Electrolyzer

liter/hour liter/day liter/mon liter/year ft3/mon ft3/year
0.94 22.56 686.2 8234.4 24.23 290.76

Electrical Needs Hogen 40 Electrolyzer

kWh/Nm3
6.7

Electrical Needs of Compressor

9% energy loss du compression

Annual Production of H2

kg/day kg/month kg/year
2.27 69.05 828.55
2.27

Input Variable

Output Variable

Utilities

Water

3/4" Water Meter/month=	\$18.28		
0-400 ft3 =	\$0.20	/ft3	
Flow rate=	24.23	ft3	
Price of water per month =	4.89		
Total Water Cost =	\$23.17	/month	\$278.09

Electricity for Electrolyzer

H2 Production =	1.05	Nm3/h	
	25.2	Nm3/day	
Power Consumed =	6.7	kWh/Nm3	
	168.84	kWh/day	
Price for Power =	\$0.09	/kWh	
Electricity Cost =	\$15.58	\$/day	
	473.91	\$/month	5686.90

Electricity for Compressor

Utilizes 9% of Energy in H2			
HHV of H2 =	39	kWh/kg	
Amount of H2 =	2.27	kg/day	
Energy Used =	7.97	kWh/day	
Electricity Cost =	\$0.74	/day	
	22.36	\$/month	268.37

Maintenance =	\$683	/year	683	\$683.00
---------------	-------	-------	-----	----------

Total Annual Operating Costs = \$6,916.37

Total Capital Costs = \$210,414.00

Annualized Worth Over 10 Year Period

IRR = 10% (A/P, 10%, 10yr) + Operating Costs

i=	0.08	P=	\$210,414.00	A =	\$38,274.26
n=	10	years			

A = P(A/P, I, N) = 31357.89 \$/year

Cost of H2 Per Kg for this Facility = \$46.19

APPENDIX B-List of Acronyms

AVTF	Advanced Vehicle Test Facility
C	Celsius
CAD	Computer Aided Design
CARTA	Chattanooga Area Regional Transportation Association
CCS	Carbon Capture Sequestration
CFCs	Chlorofluorocarbons
CNG	Compressed Natural Gas
DOE	U.S. Department of Energy
DOT	U.S. Department of Transportation
FTA	Federal Transit Administration
GPS	Global Positioning Satellite
ICE	Internal Combustion Engine
ISO	International Organization of Standardization
ITS	Intelligent Transportation Systems
Kg	Kilogram
LNG	Liquefied Natural Gas
MPG	Miles Per Gallon
MPkg	Miles Per Kilogram
NFPA	National Fire Protection Association
OSHA	Occupational Safety and Health Administration
PEM	Proton Exchange Membrane
PSI	Pounds Per Square Inch
SOFC	Solid Oxide Fuel Cell
TIES	Topographic Inertial Energy Simulator
UTC	University of Tennessee at Chattanooga
UTK	University of Tennessee at Knoxville
US	United States
VE	Value Engineering

APPENDIX C-Metric Conversion Chart

Distance		
1 inch	= 2.54 centimeters	= 25.4 millimeters
1 foot	= 0.305 meter	= 30.48 centimeters
1 yard	= 0.9144 meter	
1 mile	= 1.61 kilometers	= 5,280 feet
1 kilometer	= 1,000 meters	= 0.6214 mile
1 meter	= 100 centimeters	= 1,000 millimeters
1 meter	= 3.28 feet	
1 centimeter	= 0.3937 inch	= 10 millimeters
1 millimeter	= 0.039 inch	= 0.1 centimeter
1 micron	= 10 ⁻⁴ centimeter	= 10 ⁻⁶ meter
10 ⁻⁶ meter	= 1micrometer	
Volume		
1 kiloliter	= 1,000 liters	= 1 cubic meter
1 liter	= 1,000 milliliters	= 1,000 cc
1 milliliter	= 1 cc (exactly 1.000027 cc)	
1 fluid ounce	= 29.57 milliliters	
1 US gallon	= 3.785 liters	
1 Imperial gallon	= 4.546 liters	
Weight		
1 kilogram	= 1,000 grams	= 2.2 pounds
1 gram	= 1,000 milligrams	= 0.035 ounce
1 milligram	= 1,000 micrograms	= 1/1,000 gram
1 microgram	= 10 ⁻⁶ grams	= 1/1,000 milligram
1 nanogram	= 10 ⁻⁹ grams	= 1/1,000 microgram
1 pound	= 0.45 kilogram	= 16 ounces
1 ounce	= 28.35 grams	



Federal Transit Administration
Office of Research, Demonstration and Innovation
U.S. Department of Transportation
1200 New Jersey Avenue, SE
Washington, DC 20590

<http://www.fta.dot.gov/research>

Report No. FTA-TN-26-7032-2009.1