

Modeling and Control of an SOFC APU

Moe Khaleel

Xin Sun, Ning Lu, Brian Koeppel, Ba Nghiep Nguyen, Sudip Mazumder

Pacific Northwest National Laboratory

DOE Hydrogen Program Review, Arlington, VA

May 23, 2005

This presentation does not contain any proprietary or confidential
information

Project Overview

Timeline

- ▶ Project start date: Jan 2003
- ▶ Project end date: Sept 2007
- ▶ Percent complete: 60%

Budget

- ▶ FY05 funding: \$500k
- ▶ FY06 funding: \$500k

Partners

- ▶ PACCAR
- ▶ University of Illinois, Chicago
- ▶ Delphi
- ▶ GE

Barriers

- ▶ A. Durability
- ▶ D. Thermal Management
- ▶ F. Fuel Cell Power System Integration
- ▶ G. Power Electronics

Targets

- ▶ (2015) Efficiency: 40%
- ▶ (2015) Cycle Capability: 250
- ▶ (2015) Durability: 35,000 hours
- ▶ (2010) Start-up Time: 15-30 min

Project Objectives

SOFC-based APU development with a) control algorithms to optimize fuel efficiency and operating life, and b) models and experiments for stack response and structural failure under dynamic loading

▶ System & Controls

- Develop dynamic system models
- Determine typical APU usage patterns
- Collect electrical usage data from a working truck
- Design control algorithms to optimize fuel efficiency and stack operating life

▶ Shock & Vibration

- Identify failure modes under characteristic dynamic loading
- Experimentally determine material behavior under dynamic loading
- Determine guidelines for durable SOFC/APU systems
- Measure truck excitations and experimentally validate the models
- Define requirements for APU isolation

Project Accomplishments

▶ Task 1: System & Controls Analysis

- Developed a lumped model for SOFC stack electrochemistry, thermal and transient response
- Developed control algorithms for stacks under electrical/thermal transient conditions
- Developed power electronics models
- Measured electrical load needs by PACCAR

▶ Task 2: Shock & Vibration Analysis

- Developed damage model for glass-ceramic seals
- Developed model to predict interfacial crack growth
- Implemented basic fatigue criterion for stack materials
- Developed probabilistic framework for design sensitivity

Technical Approach

Task 1: System & Controls Analysis

- ▶ Develop advanced algorithms to control an SOFC based APU system for Class VIII trucks. The controller seeks to optimize fuel efficiency and system operating life.
 - Create a dynamic system model of APU operation.
 - Temperature can not change instantaneously because of the **thermal dynamics** caused by thermal capacity of the air, fuel, and SOFC stack.
 - Reaction rates of the chemical reactions can not change instantaneously because of the **electrochemical dynamics** caused by reactants.
 - Flow rates of the fuel and air can not change instantaneously.
 - Use experimental validation to improve models.
 - Design separate controllers for start-up and operating phases
 - Integrate APU, power electronics and control models into a single operating model.
 - Create modular models to allow investigation of different connectivity options and allow for continuing improvements
 - Model power system to convert SOFC voltage to fixed bus voltage
 - External electrical load based on experimentally measured load profiles for Class VIII trucks

Progress and Results

Task 1: System & Controls Analysis

A lumped electrochemical and thermal dynamic model of SOFC

Controls

- The APU system is a multi-input, multi-output (MIMO) control problem. The controller's functionality is to ensure the APU is operating at the required electrical load at all times, while minimizing fuel use. Long heat-up times for the SOFC mean that the controller must anticipate load requirements.

Approach

- Design separate controllers for heat-up and operating phases.
- Controller predicts load requirements based on prior usage.
- Build system identifiers to infer internal, distributed parameters of the SOFC stack.

Results

- Completed controller for heat-up phase. Controls cathode air temperature based on stack temperature to prevent thermal shock and fatigue in SOFC stack.
- Implement operating phase controller.

Next Steps

- Implement operating phase controller on heat exchangers and reformers.
- Interface SOFC model with power converter models.

Control Variables

- Fuel flow rate
- POX air flow rate and temperature
- Reformate temperature
- Cathode air flow rate and temperature
- Anode re-circulation percentage
- Stack current

System Outputs

- Stack Voltage
- Fuel Utilization
- Anode and cathode exhaust
- Stack Temperature

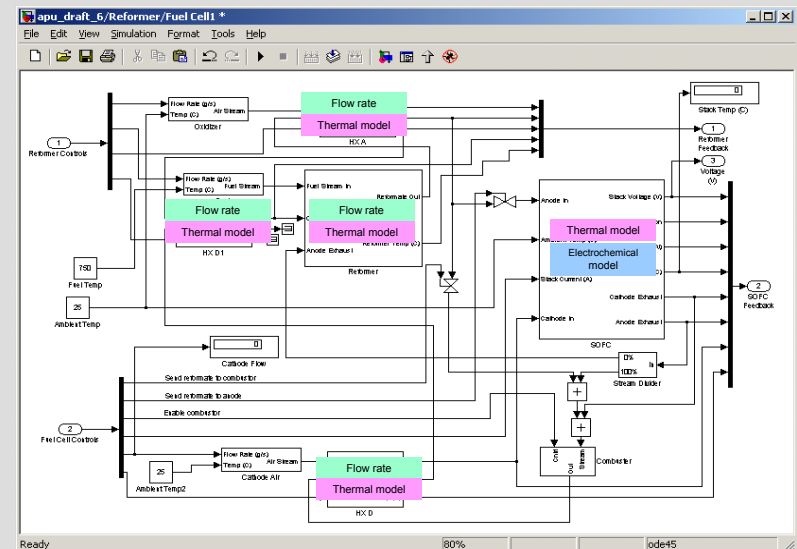

Progress and Results

Task 1: System & Controls Analysis

A lumped thermal dynamic model of SOFC

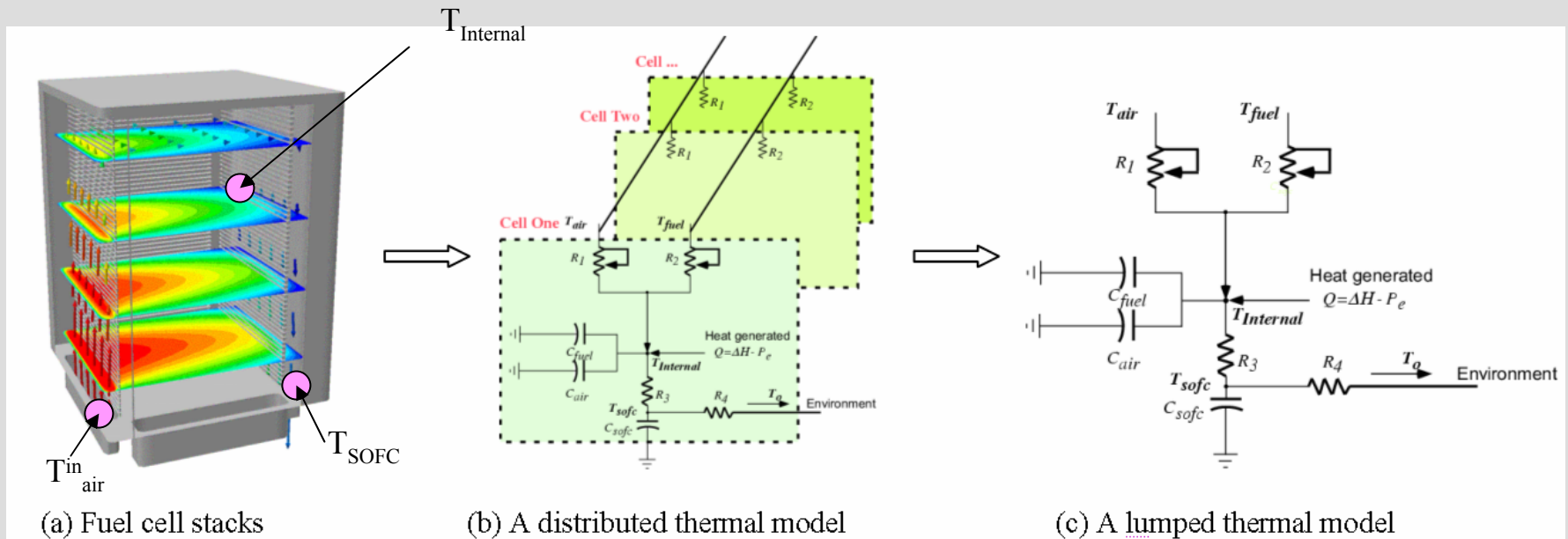

Figure 1: Thermal models for a SOFC stack

Progress and Results

Task 1: System & Controls Analysis

A State-Space Representation of the Thermal Model

$$(C_{fuel} + C_{air}) \frac{dT_{Internal}}{dt} = \frac{(T_{air} - T_{Internal})}{R_1} + \frac{(T_{fuel} - T_{Internal})}{R_2} + \frac{(T_{sofc} - T_{Internal})}{R_3} + Q$$

$$C_{sofc} \frac{dT_{Internal}}{dt} = \frac{(T_{Internal} - T_{sofc})}{R_3} + \frac{(T_o - T_{sofc})}{R_4}$$

$$\dot{x} = Ax + Bu$$

$$y = Cx + Du$$

$$\dot{x} = \begin{bmatrix} \dot{T}_{Internal} \\ \dot{T}_{sofc} \end{bmatrix} \quad x = \begin{bmatrix} T_{Internal} \\ T_{sofc} \end{bmatrix} \quad u = \begin{bmatrix} T_{air} \\ T_{fuel} \\ T_o \\ Q \end{bmatrix}$$

$$A = \begin{bmatrix} -\left(\frac{1}{R_1 C_1} + \frac{1}{R_2 C_1} + \frac{1}{R_3 C_1}\right) & \frac{1}{R_3 C_1} \\ \frac{1}{R_3 C_2} & -\left(\frac{1}{R_3 C_2} + \frac{1}{R_4 C_2}\right) \end{bmatrix} \quad B = \begin{bmatrix} \frac{1}{R_1 C_1} & \frac{1}{R_2 C_1} & 0 & \frac{1}{C_1} \\ 0 & 0 & \frac{1}{R_4 C_2} & 0 \end{bmatrix}$$

$$C = \begin{bmatrix} 1 & 0 \\ 0 & 1 \end{bmatrix} \quad D = \begin{bmatrix} 0 & 0 & 0 & 0 \\ 0 & 0 & 0 & 0 \end{bmatrix}$$

Progress and Results

Task 1: System & Controls Analysis

Start-up Mode

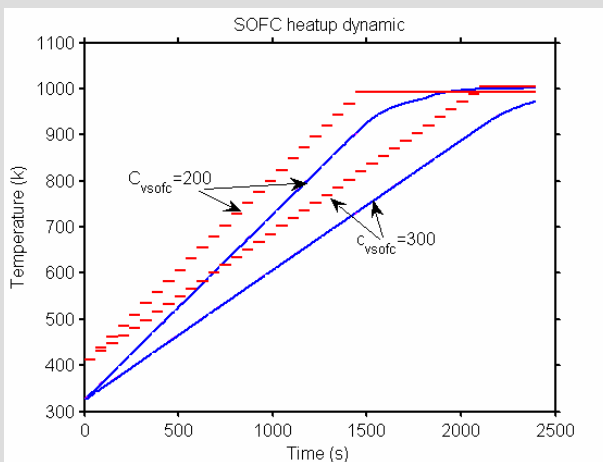
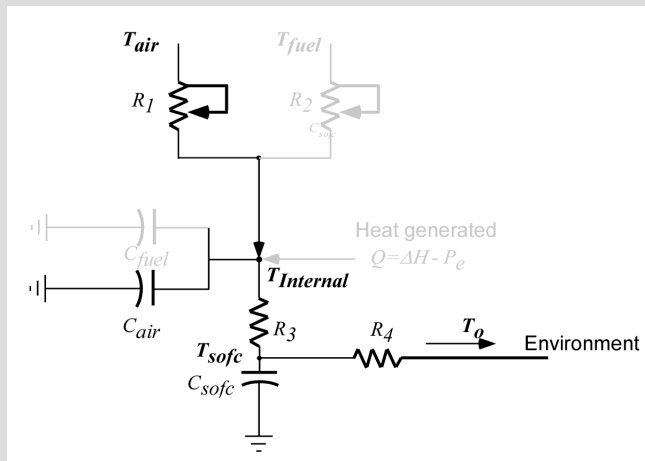

Operating Mode

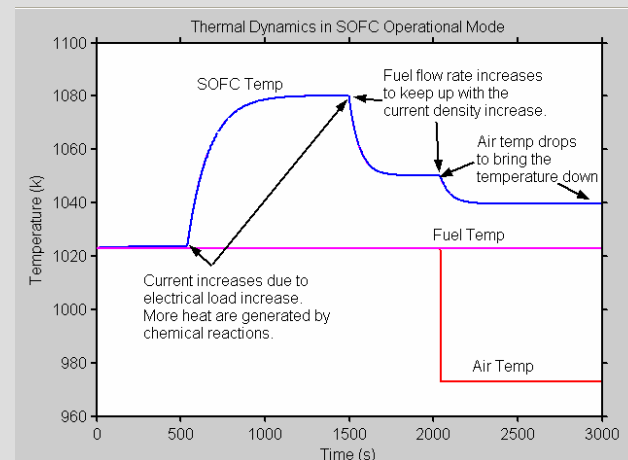
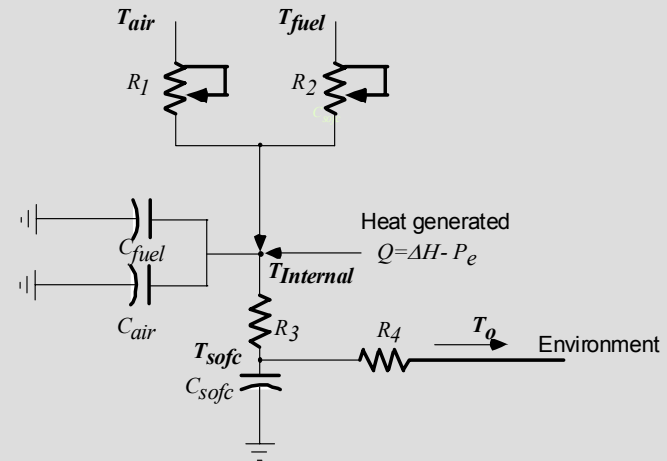

Progress and Results

Task 1: System & Controls Analysis

Start-up Mode

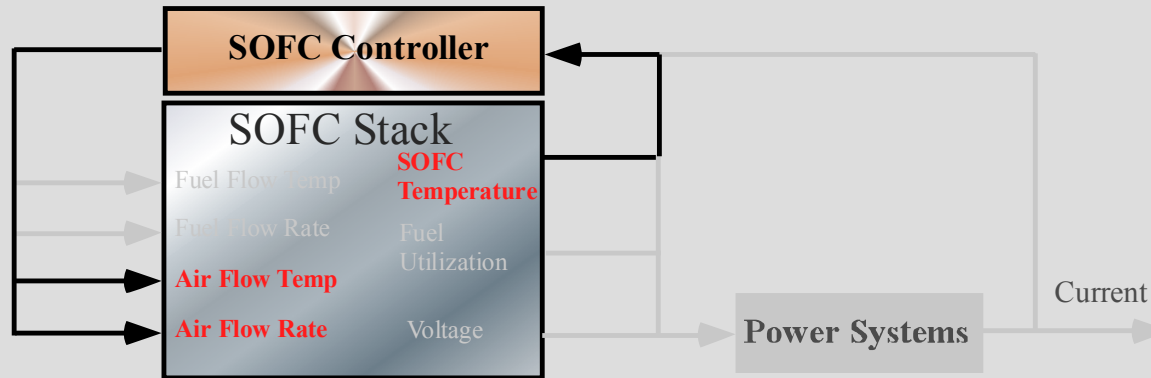

- A simplified thermal model is used.
- The temperature gradient inside the SOFC can be modeled by detailed thermal model. Sensors will be installed in the SOFC stack to get the temperature measurements. The air flow temperature will be adjusted such that at any time, $(T_{\text{air}} - T_{\text{stack}})$ will not exceed the set values provided by the stress analyses to prevent thermal shock of the stack.
- Parameters of the simplified model can be tuned by experimental data obtained for each fuel cell stack.

Progress and Results

Task 1: System & Controls Analysis

Operating Mode

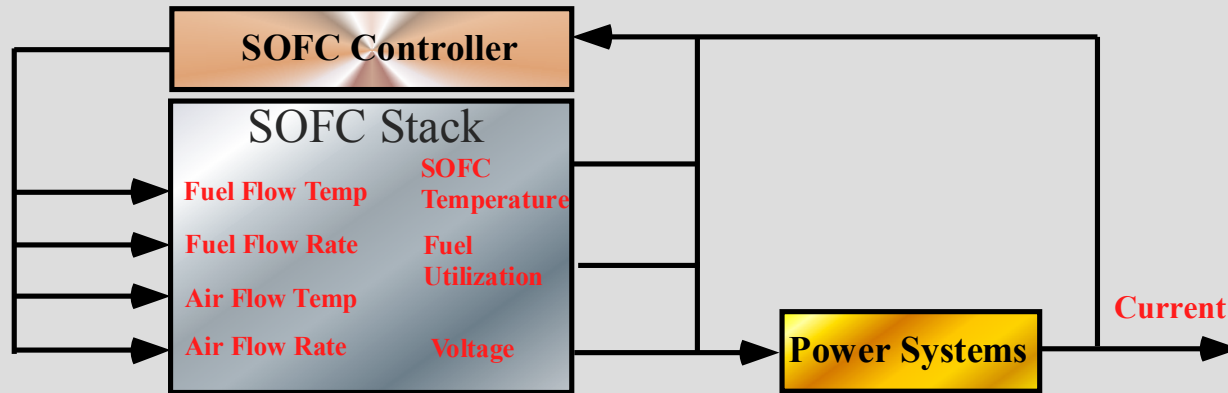

► Operating mode controller

- Fuel flow temperature shall be relatively fixed.
- SOFC temperature → air flow temperature and rate
- Fuel utilization → fuel flow rate and air flow rate
- Electrical load → current → voltage → fuel flow rate
→ Q → air flow rate and temperature

Progress and Results

Task 1: System & Controls Analysis

Transient caused by a step change of current

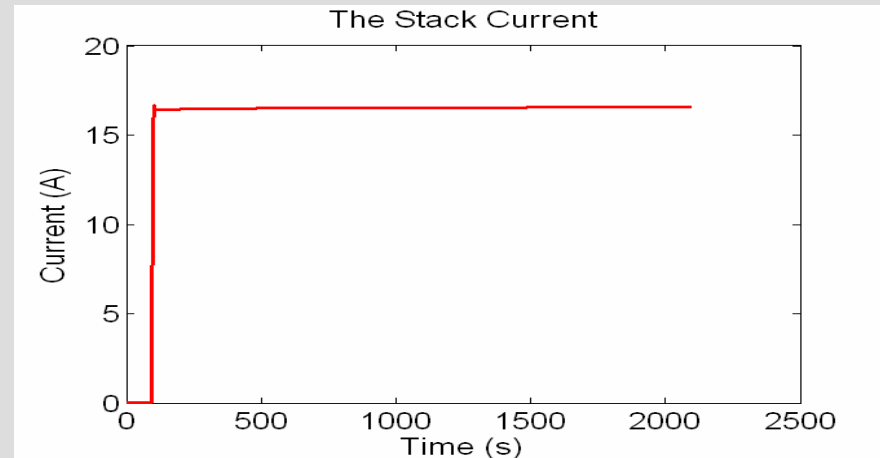
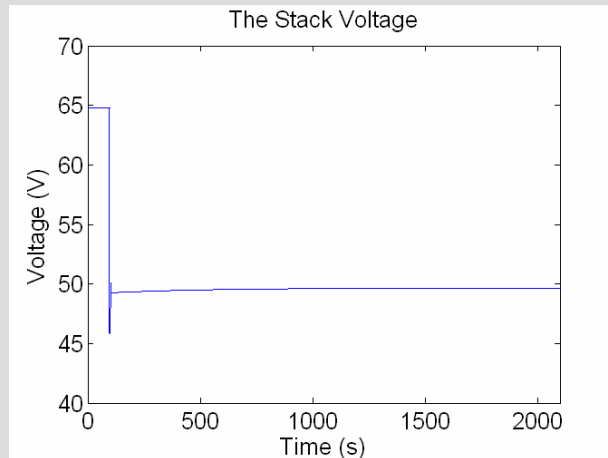
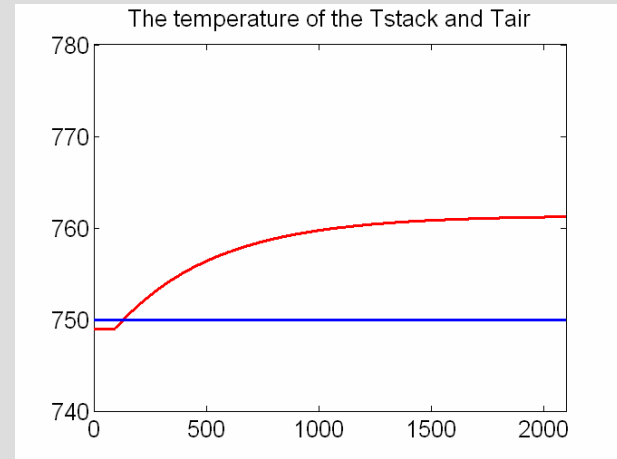
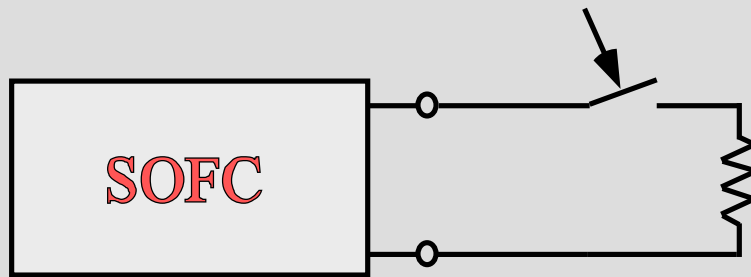

Progress and Results

Task 1: System & Controls Analysis

Transient caused by fuel flow rate changes

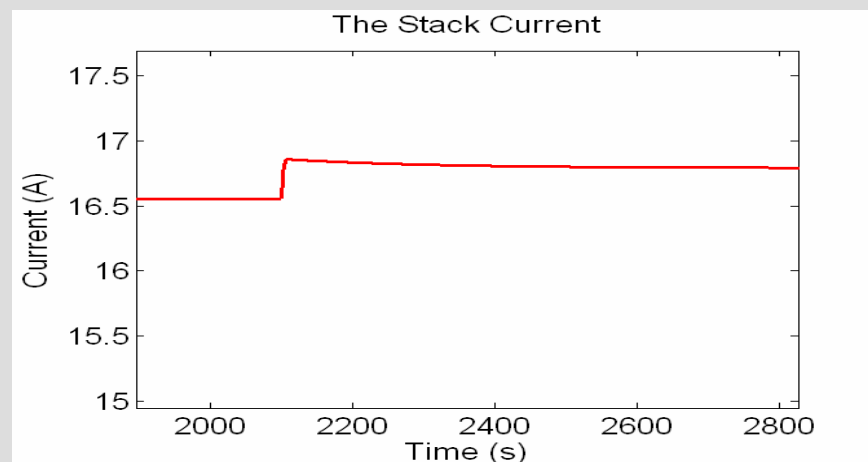
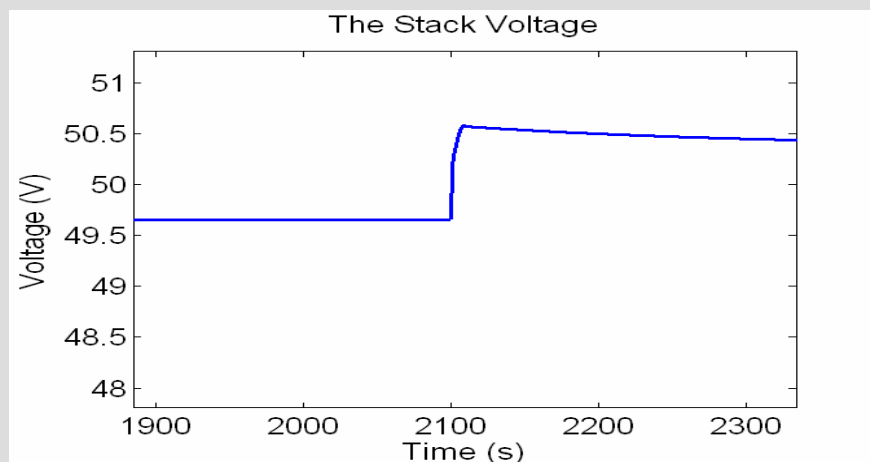
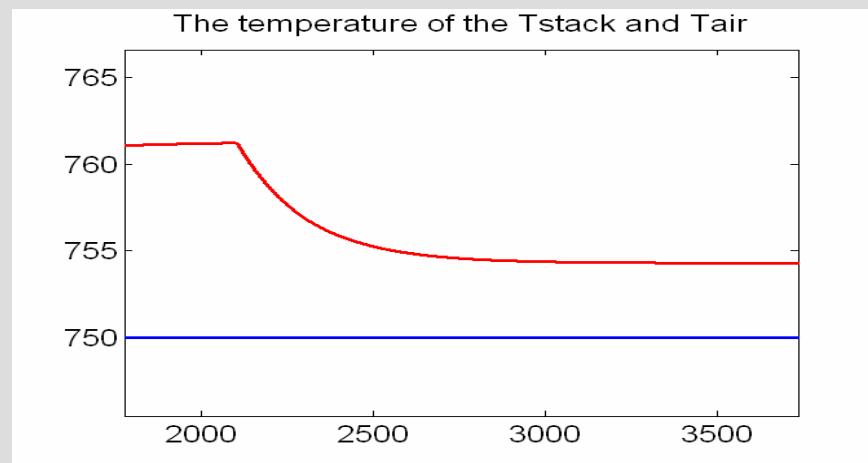
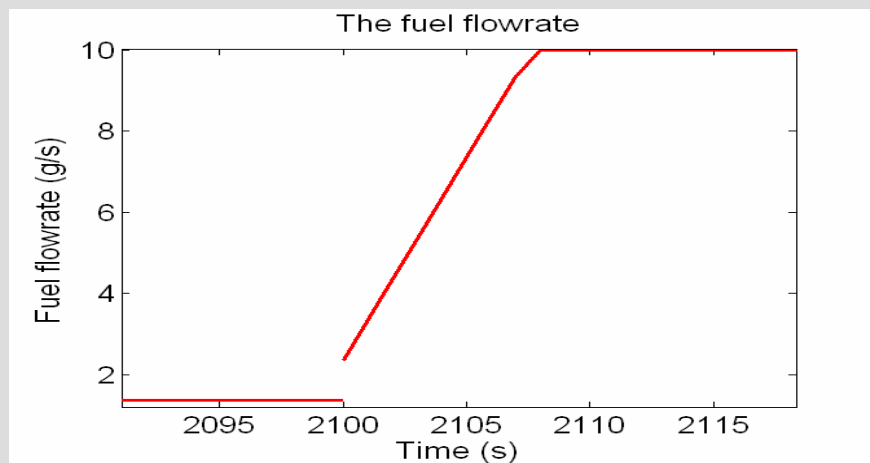

Progress and Results

Task 1: System & Controls Analysis

MATLAB model of electrical system/load

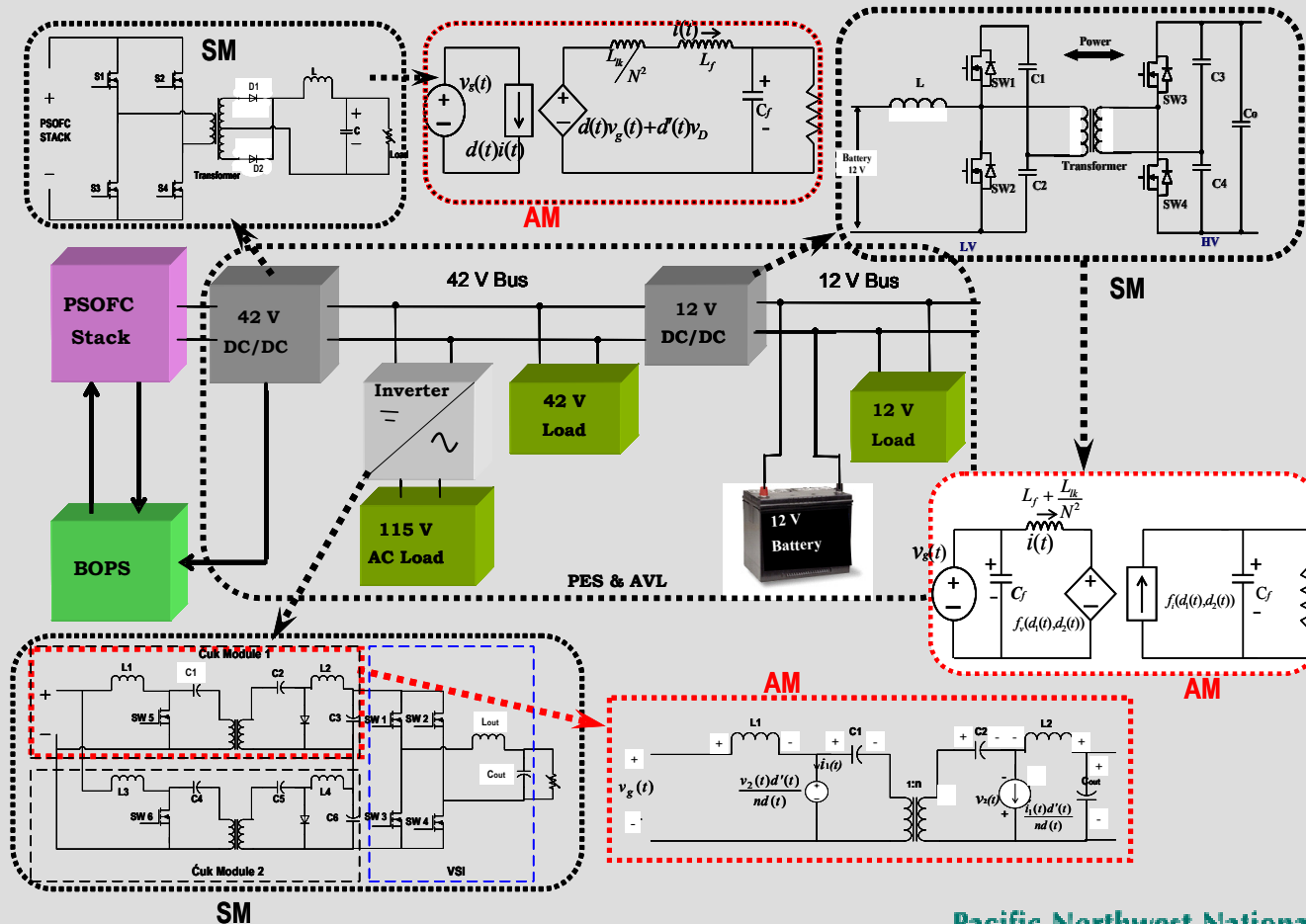

Progress and Results

Task 1: System & Controls Analysis

SIMULINK model of the Power Electronics System

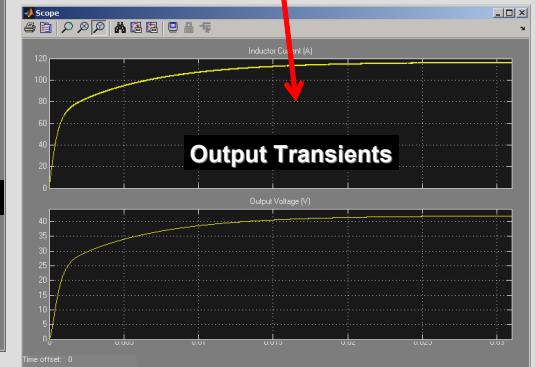
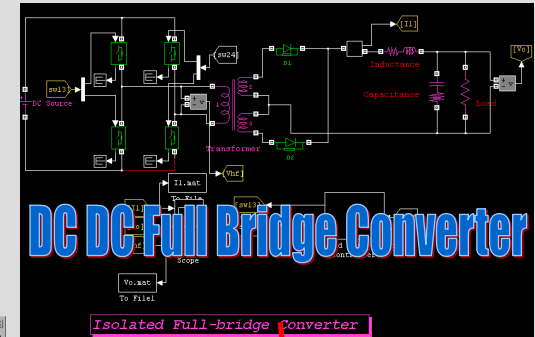
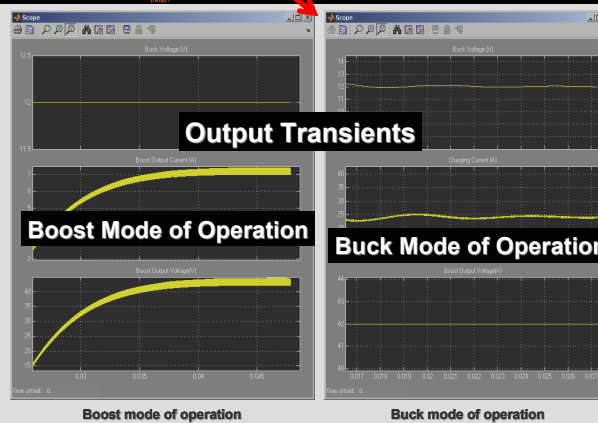
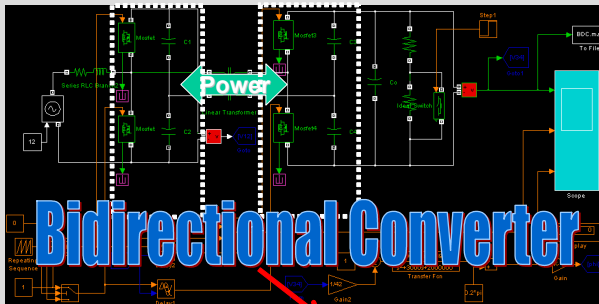
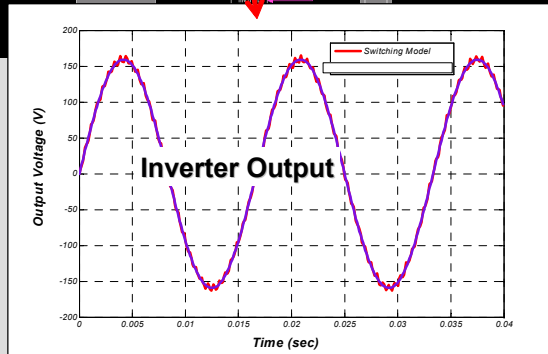
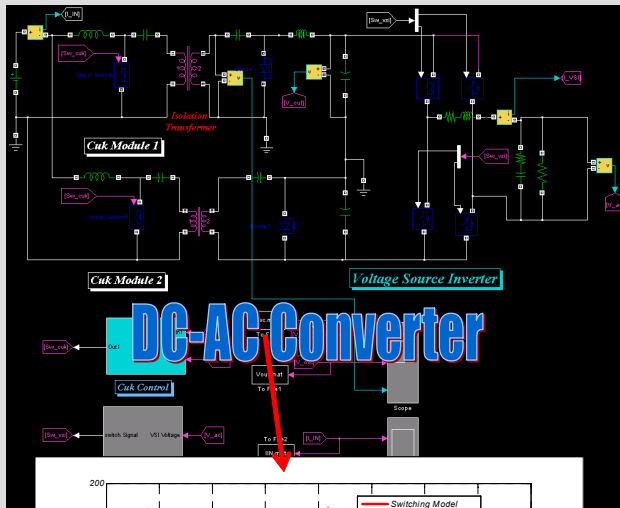

Technical Approach

Task 2: Shock & Vibration Analysis

- ▶ Evaluate mechanical dynamics of APU
 - Simple, fast lumped parameter representation
 - Determine experimental behavior of seal and stack materials under dynamic loads
- ▶ Evaluate dynamic response of SOFC stack
 - Assumes stack is component most prone to damage
 - Detailed multi-cell stack finite element model
- ▶ Evaluate stresses in the stack against failure criteria to determine permissible accelerations
 - Permissible acceleration envelope is defined by criteria
- ▶ Measure excitation levels from truck frame
- ▶ Define APU isolation requirements based on expected excitations for Class VIII trucks

Technical Approach

Task 2: Shock & Vibration Analysis

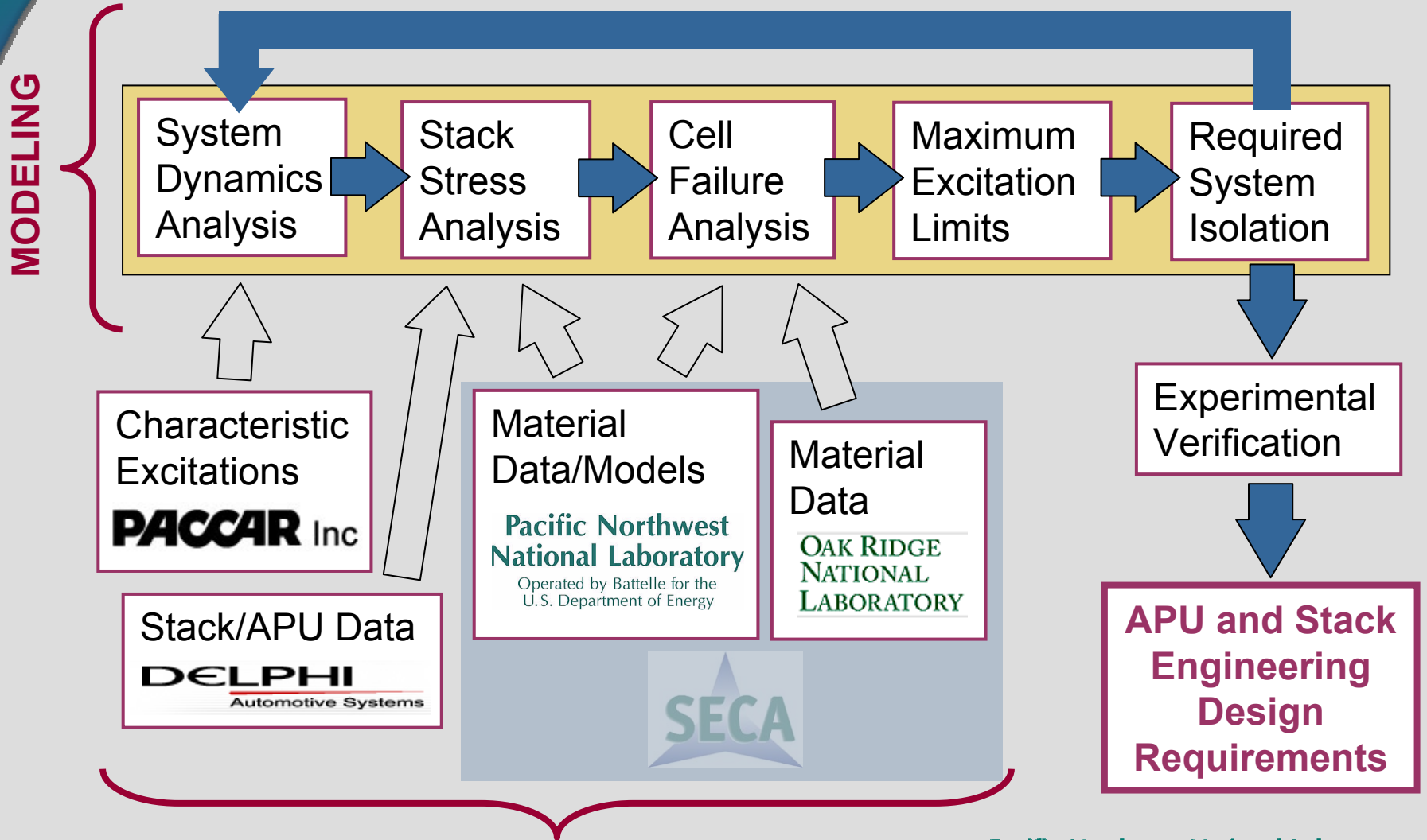

Task 2: Cell Failure Analysis

Seal Material Testing

- ▶ Models use data from PNNL SECA CTP for static strength and failure properties of cell materials (e.g. G18 glass)
- ▶ Studies being extended to evaluate crack growth and fatigue response of the G18 sealing glass
 - Cyclic fatigue testing is currently in progress
 - (Mechanical response is currently dominated by interfacial reactions, but protective coatings may remedy this)

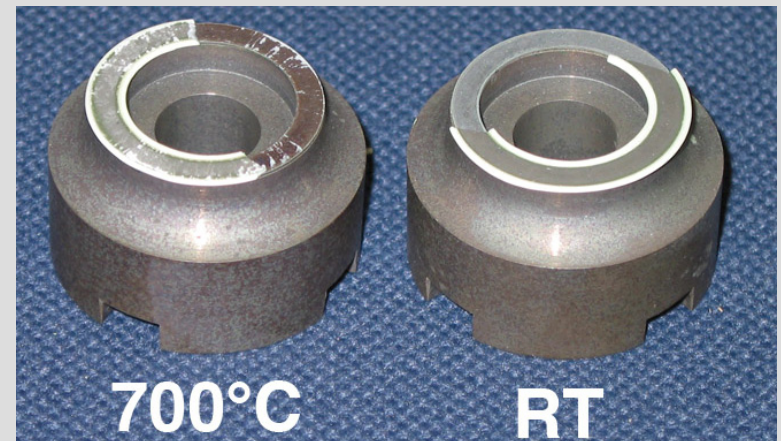
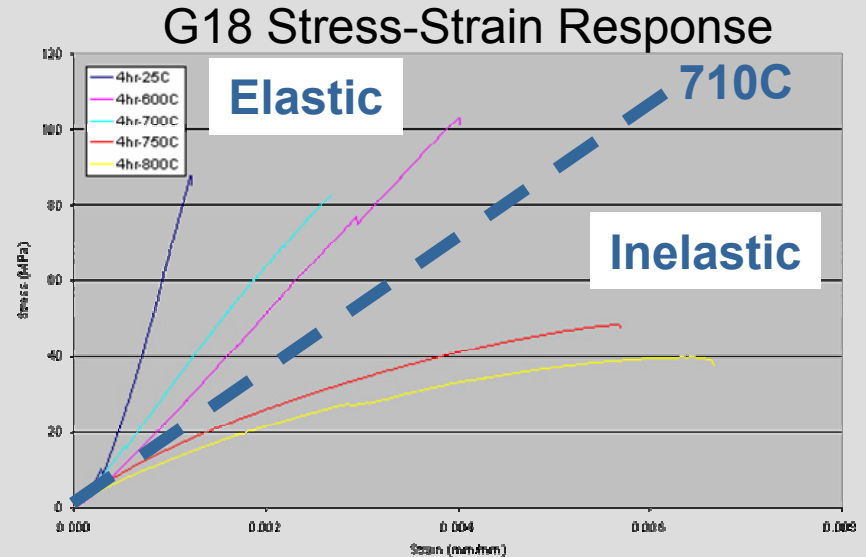

Task 2: Cell Failure Analysis

Model for Interface Failure

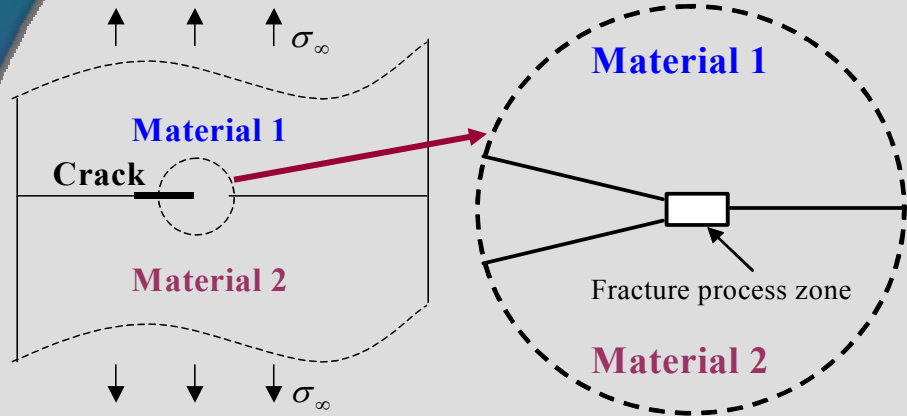

Fine Crack Tip Mesh

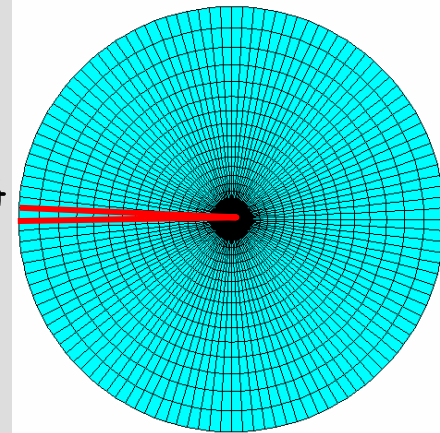

Interface Toughness

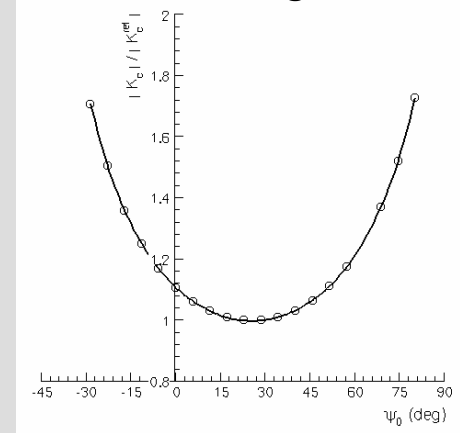

► Objectives

- Determine fracture toughness and crack resistance behavior of the interfaces between G18 sealant glass and other SOFC materials
- Provide insights on the governing parameters which can be optimized to improve interface toughness and crack resistance
- Reduce the amount of experiments needed for designing APU SOFC stacks

► Technical approach

- A modified boundary layer (MBL) modeling approach was developed
- A continuum damage model for G18 was developed and used in the MBL
- Model implementations in ABAQUS for numerical simulations

Task 2: Cell Failure Analysis

Model for Interface Failure

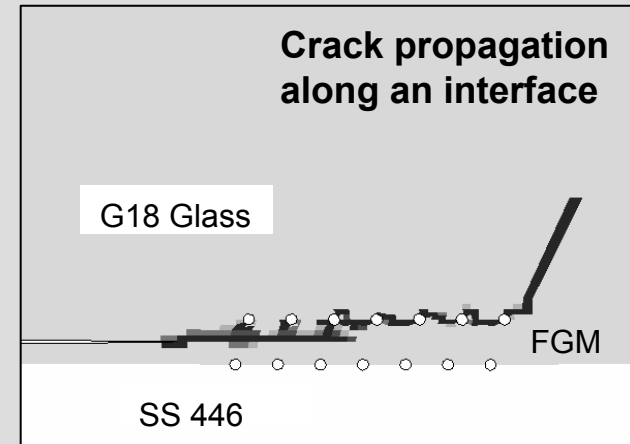
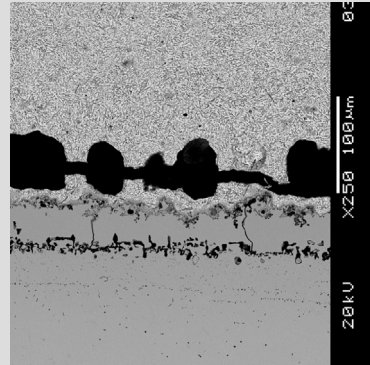
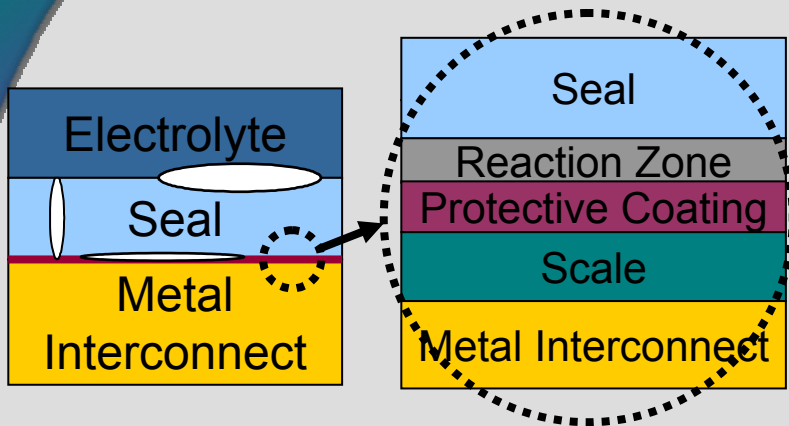

- ▶ Chemical reactions severely degrade interfaces between glass seals and metallic interconnects
- ▶ Interface layers developed between the G18 and metal interconnects (i.e coating, reaction zone,...)
- ▶ Pore distribution along the reaction zone
- ▶ Interface layers were modeled by a simple functionally graded material (FGM) model
- ▶ The developed CDM model describes the fracture behavior of glass seal interface

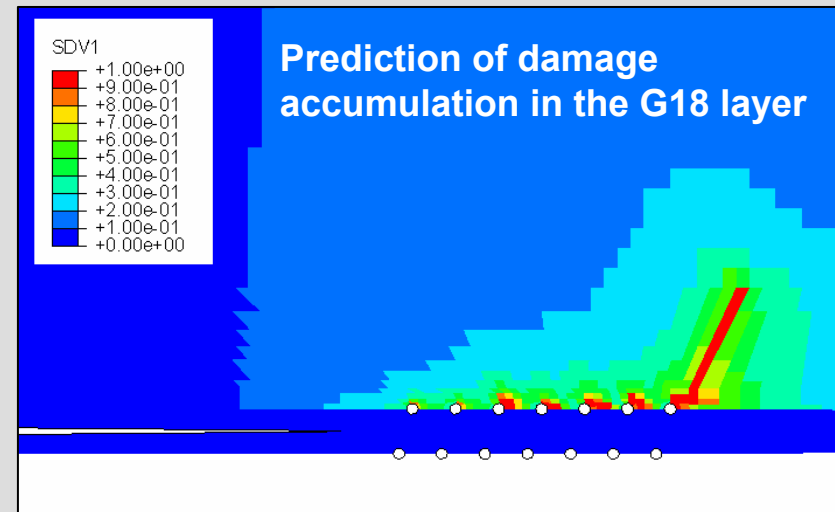

Task 2: Cell Failure Analysis

Cell Fatigue Criterion

- ▶ Failure criteria shown previously suitable to define maximum excitations for short term loading
- ▶ Need criteria for continuous or cyclic loading of components
- ▶ Implementing a fatigue model for crack growth in brittle materials
 - Subcritical crack growth expected in cell materials due to H_2 , O_2 , and H_2O environment

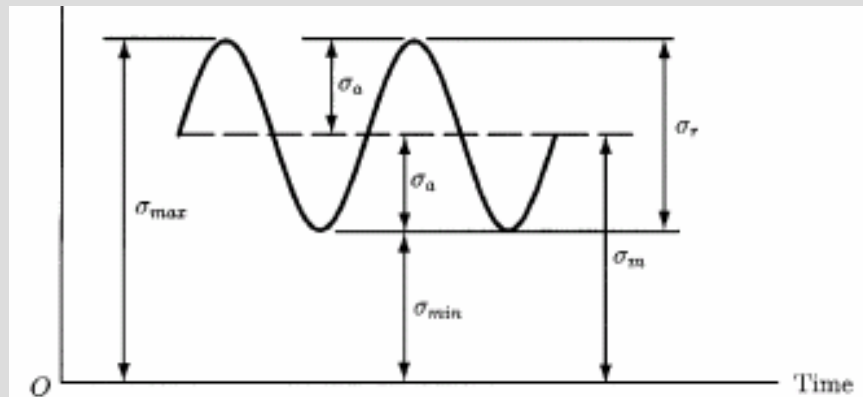

▶ Approach- Static Fatigue

- Identify the remote stress
- Assume a pre-existing flaw and select a crack geometry
- Select a fatigue crack propagation model for the material (e.g. Paris law)

$$\frac{da}{dt} = A(K)^m$$

- Determine the stress intensity factor
- Get the fracture toughness
- Calculate critical crack length
- Calculate the time to failure (i.e. growth of pre-existing initial crack to critical size)

Task 2: Cell Failure Analysis

Cell Fatigue Criterion

► Approach- Cyclic Fatigue

- Similar to static fatigue
- Identify the cyclic stress range and history
- Select a fatigue crack propagation model for the material (e.g. Walker law)

$$\frac{da}{dN} = C(\Delta K)^n$$

- Determine the range of stress intensity factor
- Calculate the cycles to reach a critical crack size

► Literature data for cracks

- For 8YSZ electrolyte, $n=20$ is typical.

► Implementing in the ANSYS routines to provide results contours for cell materials

Electrolyte Static Fatigue
Axial and bending stresses: 50MPa

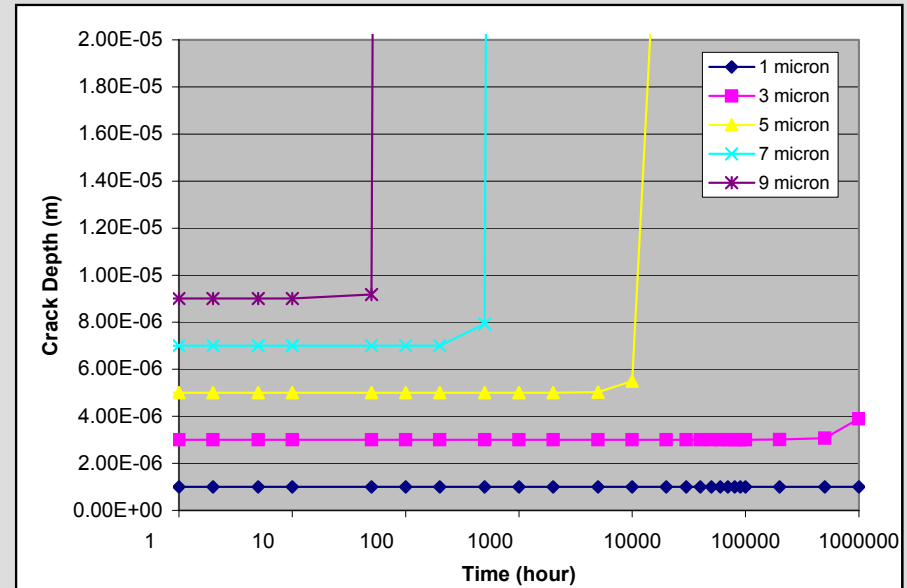

Task 2: Cell Failure Analysis

Fatigue Damage Model

- ▶ A CDM model for glass-ceramic materials was developed under SECA to predict damage in rigid seals until failure. This damage model is constructed from the experimental stress/strain curves with a damage variable defined by the reduction of elastic modulus
- ▶ Currently, the damage model is being extended to account for viscoelastic behavior and fatigue damage
 - The damage variable will now also be a function of the number of cycles
- ▶ The fatigue-damage model will be used with the interface model to predict fatigue life for seal interfaces
- ▶ Results will be used with the stack model as a criterion for high cycle fatigue failure to define required isolation
- ▶ Fatigue tests for the glass-ceramic seal material are being performed at PNNL

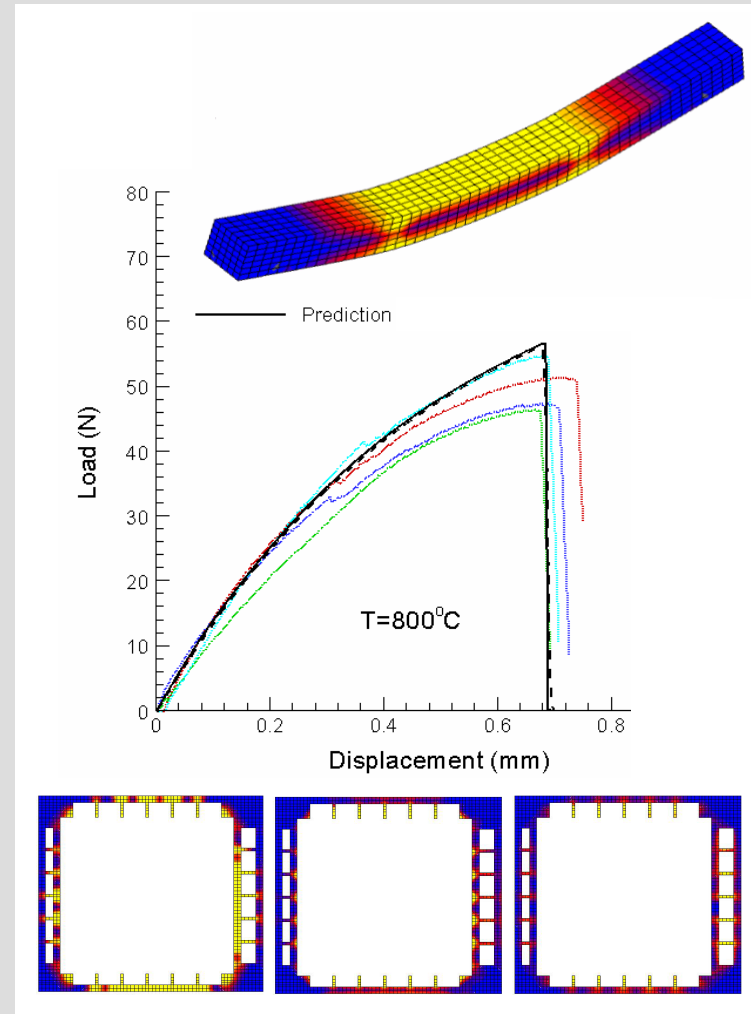

Task 2: System Dynamics Analysis

Characterization of Stack Damping

- ▶ Materials' inherent mechanisms of energy dissipation (damping) is beneficial for stack dynamic response
- ▶ Mechanisms and temperature dependence very different for each materials
 - Individual cell materials characterized
 - Literature data on internal friction measurements sufficient for the models

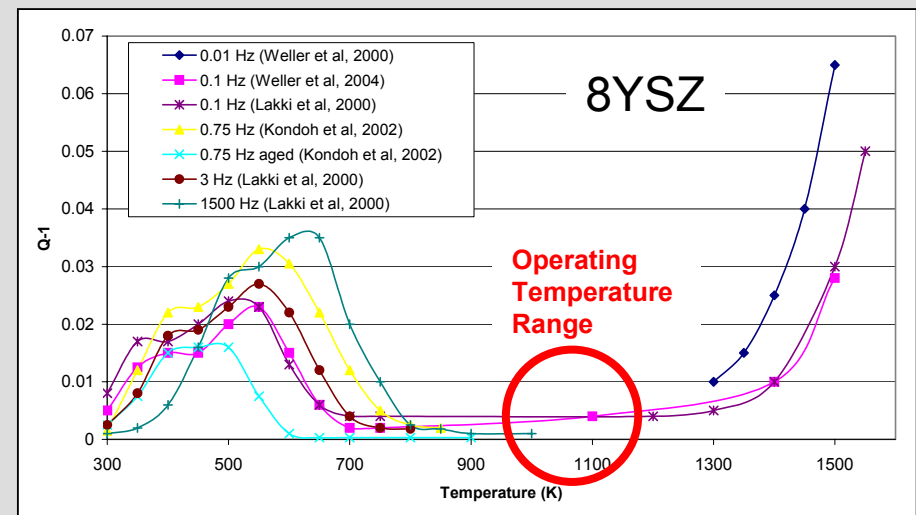
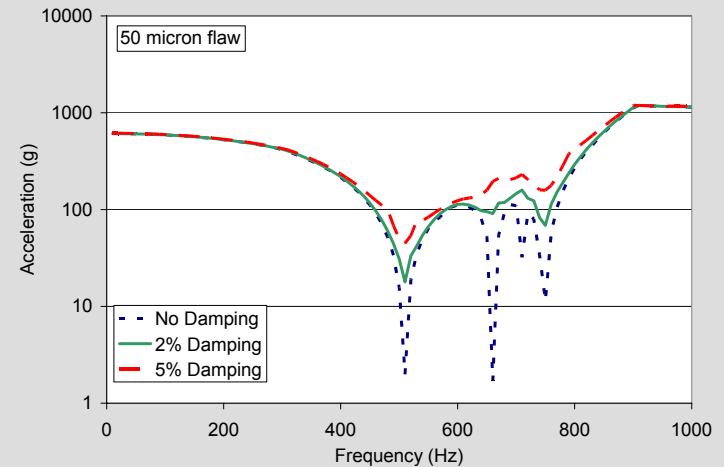

Task 2: Stack Stress Analysis Framework for Design Sensitivity

▶ A framework for design sensitivity was developed using the probabilistic design tools in ANSYS

- Identified component sensitivities and trends
- Made stress-based reliability estimates

▶ This framework will be used with the stack model and failure criteria to:

- determine isolation sufficient for a reasonable range of SOFC cell parameters
- estimate component lifetimes based on fatigue models

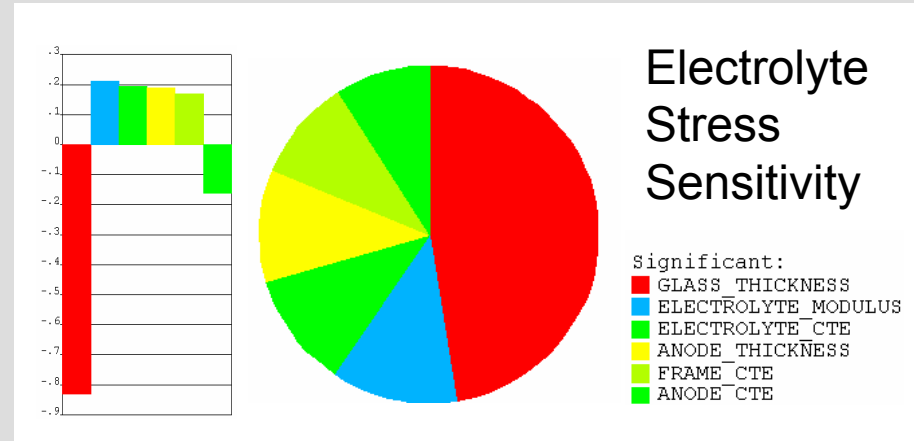

Electrolyte Stress vs Seal Thickness

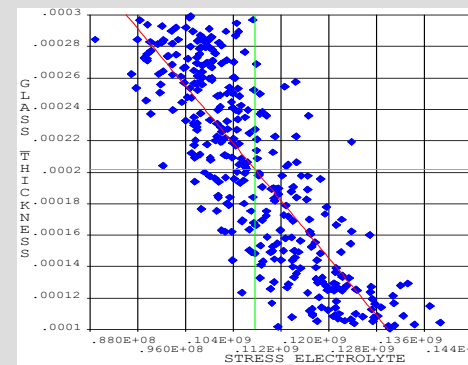

Electrolyte Reliability

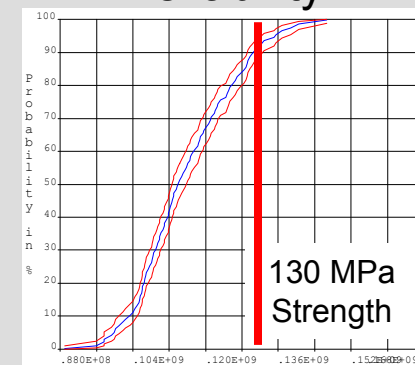

Task 2: Maximum Excitation Limits

PACCAR Data Collection

Experimental Data Collection

- PACCAR acceleration amplitudes
- Data useful but not comprehensive
 - No frequency content
 - No measures during idling and highway conditions
 - Test geometry unknown
- APU mock-up in progress
 - Realistically captures mass and mass distribution of APU
 - Mounted on truck in expected location between frame rails
 - Data measured at frame to characterize APU base excitation
 - Data measured at multiple locations to capture individual component response to use for model calibration
 - Amplitude and frequency content for 3 axes during each event

Sensor	3" chuck hole	Broken Concrete, 10 mph	Diagonal Bumps	Hard Stop
APU, vertical	4.63/-1.73	12.2/-4.67	17.49/-8.50	1.47/-1.26
APU, lateral	1.16/-1.85	4.68/-6.75	5.78/-6.36	0.55/-0.36
APU, fore/aft	1.08/-0.59	2.82/-3.02	2.69/-2.90	1.40/-0.46
Frame, vertical	2.16/-1.73	3.96/-3.46	4.11/-3.45	0.50/-0.74
Frame, lateral	1.51/-1.19	2.88/-3.25	3.49/-2.73	0.35/-0.36
Frame, fore/aft	0.72/-0.99	1.01/-1.00	1.38/-1.68	0.21/-0.90

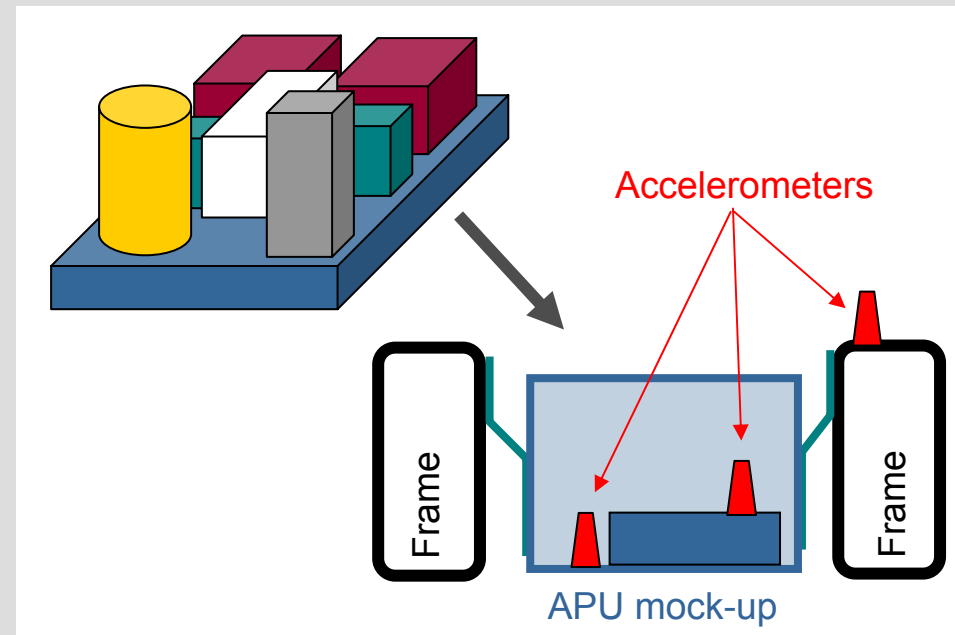

Responses to Previous Year Reviewers' Comments

- ▶ Unclear how this fits in the Hydrogen Program
 - The multi-year plan, under transportation focus, supports auxiliary power where earlier market entry would assist in a fuel cell manufacturing base
 - SOFCs applicable to heavy vehicles: higher power density, extended run times
 - Technical targets specific to APUs established (Table 3.4.9)
 - “Initiate development of auxiliary power unit systems for heavy vehicle application” –key activity, Hydrogen Posture Plan, 2004
- ▶ Determining failure modes should be key focus
 - Stack thermo-mechanical failure modes in the presence of dynamic loads are known based on extensive PNNL experimental program and are included through failure criteria in the modeling activities:
 - Cracking of electrodes/electrolyte due to thermal mismatch stresses
 - Cracking of glass-ceramic seals
 - Separation of seal/metal interconnect interface weakened by chemical reactions
- ▶ Expand model elements to include entire system
 - This is inherent in the system and controls model
 - Vibration models include influence of other components on dynamic response, but acceleration limits have not been pursued. This is very important but put to a lower priority than the stack because
 - Planar stacks can likely meet specific power requirements for an APU application but are currently not mechanically robust even in laboratory environments
 - Ancillary APU components are likely to be more application-specific

Future Work

▶ Remainder of FY 2005

- Integrate the SOFC models and power electronics models into the system model
- Optimize control logic for stack thermal management
- Collect electrical load profile for Class VIII truck
- Measure accelerations for the truck-mounted APU mock-up
- Extend damage and interface modeling to cyclic loading
- Define APU isolation requirements for stack reliability

▶ Proposed for FY 2006

- Include electrochemical and air/flow transient effects in system model
- Extension of system model and controls to full truck electrification
- Develop acceleration limits for ancillary APU components
- Bench-testing of an SOFC stack and/or APU system for characterization and model validation

Publications and Presentations

- ▶ BN Nguyen, BJ Koeppel and MA Khaleel, “Crack Growth in Solid Oxide Fuel Cell Materials: From Discrete to Continuum Damage Modeling,” submitted.
- ▶ SK Pradhan, SK Mazumder, M Hollist, J Hartvigsen, D Rancruel, MR von Spakovsky, MA Khaleel, KP Recknagle, BJ Koeppel and X Sun, “A Modeling Framework for Planar Solid-Oxide Fuel Cell based Power-Conditioning System for Vehicular APU,” submitted to IEEE Special Issue on Automotive Power Electronics & Motor Drives.
- ▶ SJ Moorehead, KD Meinhardt and MA Khaleel, “Dynamic Voltage-Current Response of a Planar Solid Oxide Fuel Cell,” to be submitted.
- ▶ BJ Koeppel, KI Johnson, BN Nguyen and MA Khaleel, “SOFC Structural Modeling,” 2004 SECA CTP Training Workshop, Richland, WA, July 12-15, 2004.
- ▶ MA Khaleel, BJ Koeppel and BN Nguyen, “Modeling and Control of an SOFC APU,” FY 2004 Annual Progress Report for Hydrogen, Fuel Cells & Infrastructure Technologies Program, 2004.

Hydrogen Safety

- ▶ The most significant hydrogen hazard associated with this project is:
 - Hydrogen, electrical, and chemical safety during transient response testing of an SOFC stack.

Hydrogen Safety

- ▶ Our approach to deal with this hazard is to follow all established laboratory safety and operational procedures including:
 - Electrical Safety
 - Less than 1kW operation
 - Power and thermal shutdown sensors on electronic load bank
 - Hydrogen Safety
 - Extensive labeling to aid identification of all components
 - Appropriate restraints and regulators on compressed gases
 - Comprehensive leak checking of gas lines and connections
 - Active ventilation system to mitigate leaks throughout the delivery system
 - Fuel and air line check valves in gas handling module
 - Purge system in gas handling module for emergency shutdown
 - Sensors and interlocks for automatic shutdown of gas handling module during laboratory power interruption, ventilation failures, or over-temperature
 - Over-pressurization sensors and exhaust ventilation in humidifier
 - Hydrogen and ventilation sensors on the hydrogen generator
 - Redundant hydrogen sensor in laboratory
 - Operators trained at offsite Hydrogen Safety course
 - Chemical Safety
 - Chemical Process Permits required for testing