

Project ID#: STP46

# Nanostructured Activated Carbon for Hydrogen Storage

Dr. Israel Cabasso

State University of New York esf –Syracuse Campus

May 23, 2005

This presentation does not contain any proprietary or confidential information

State University of New York-esf (Syracuse) and PoroGen LLC have initiated a collaborative effort to develop superior high surface area nano structured carbons for hydrogen storage. The preparation of the carbon starts with the preparation of a nano porous semicrystalline polymer precursor with nano size pores, uniform pore size distribution and high surface area. The semicrystalline structure of the nano-porous polymer material will be tailored to form activated carbons with **slit-like micro porous** structure and high target surface area. The high surface area of the polymeric precursor will aid in preparation of high surface area carbon and enable doping of the precursor material by chemical agents which, upon carbonization, will introduce specific interaction sites that will significantly increase the hydrogen storage capacity of the nano structured carbon material.

# Project Objectives

Develop and demonstrate reversible Nanostructured activated carbon hydrogen storage materials with at least 7 wt.% materials-based gravimetric capacity and 50g H<sub>2</sub>/L materials-based volumetric capacity, with potential to meet DOE 2010 system-level targets.

# Time Line

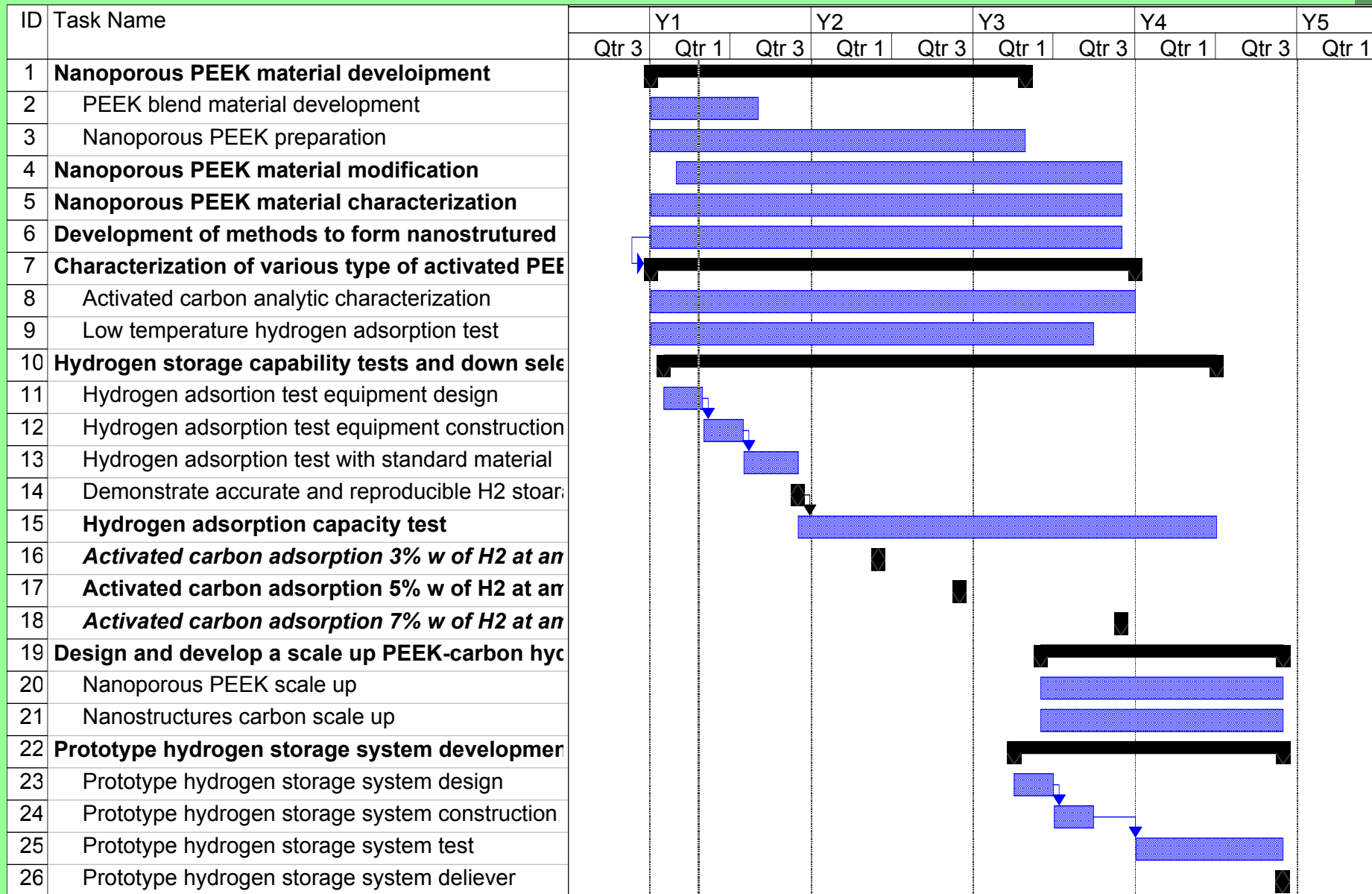

# TASKS

1. Nanoporous PEEK material preparation; blending and modification; and morphological, spectroscopical, physical and thermal characterization (using, FTIR, SAX, SEM, AFM, DSC etc.).
2. Development of methods to form nanostructure activated PEEK-carbon with high surface area and narrow pore distribution.
3. Characterization (morphological, physical, thermal and N<sub>2</sub> adsorption) of various type of activated PEEK-carbon.
4. Hydrogen storage capability tests and down-select optimum material; design and develop a scale up PEEK-carbon hydrogen storage system
5. Hydrogen storage system prototype development measurements

# Projected Milestone

Synthesis of at least 5 materials and demonstrate reproducible measurement of storage capacity (year 1-2)

Down-selection of optimum material: demonstration of material with reversible capacity  $> 3$  wt.% and  $21 \text{ g H}_2/\text{L}$  based on volumetric capacity at ambient temperature ( 18 month, year 2)

Down-selection of two compositions viable for a reversible capacity of greater than 5 wt.% and  $35 \text{ g H}_2/\text{L}$  based on volumetric capacity at ambient temperature ( end of year 2)

Optimization of hydrogen storage material to achieve system storage capacity of 7-8 wt.% and  $50 \text{ H}_2/\text{L}$  based on volumetric capacity at ambient temperature (year 3-4)

## Budget for 4 year program

\*Total \$1,935,187

DOE:\$1,543,420

Cost Share: \$391,767 (20%)

Total DOE funding for **FY05** (Sept): \$80.000

---

---

Continuation of work FY05:

Nanoporous PEEK material development

Nanoporous PEEK material modification

Nanoporous PEEK material characterization

Low temperature hydrogen adsorption test

# Technical Approach

## Processing the PEEK.

Processing the PEEK/PEI precursor at high melt shear rates further controls the morphology and orientation of crystalline regions. Highly oriented lamellae crystals in the nanoporous PEEK material is achieved by extruding the PEEK/PEI blend at high draw ratios. Highly orientation of polymeric chains and the alignment of crystalline lamellae regions lead to formation of porous material with oriented nano size pores and are expected, upon carbonization to produce activated carbon with angstrom-size slit-like pores.

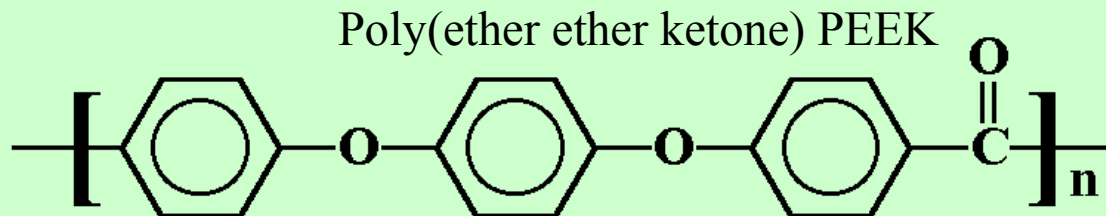



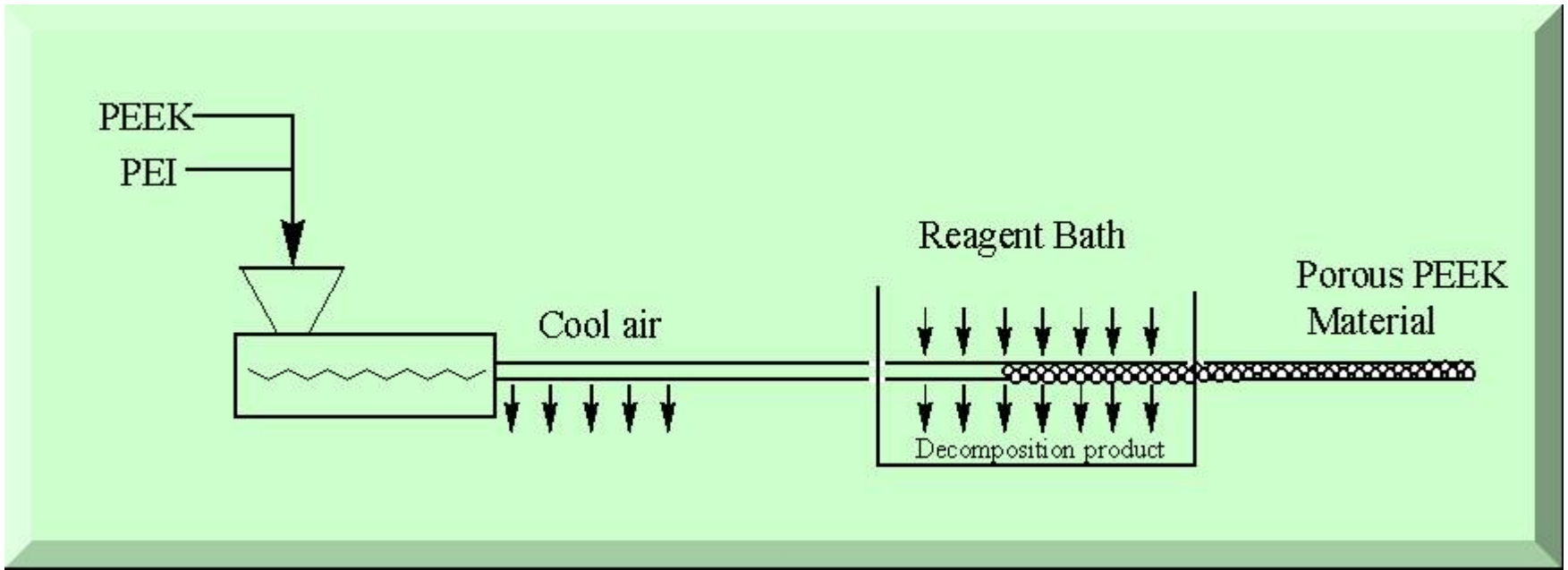

The poly(etherimide) decompose into low molecular weight fragments

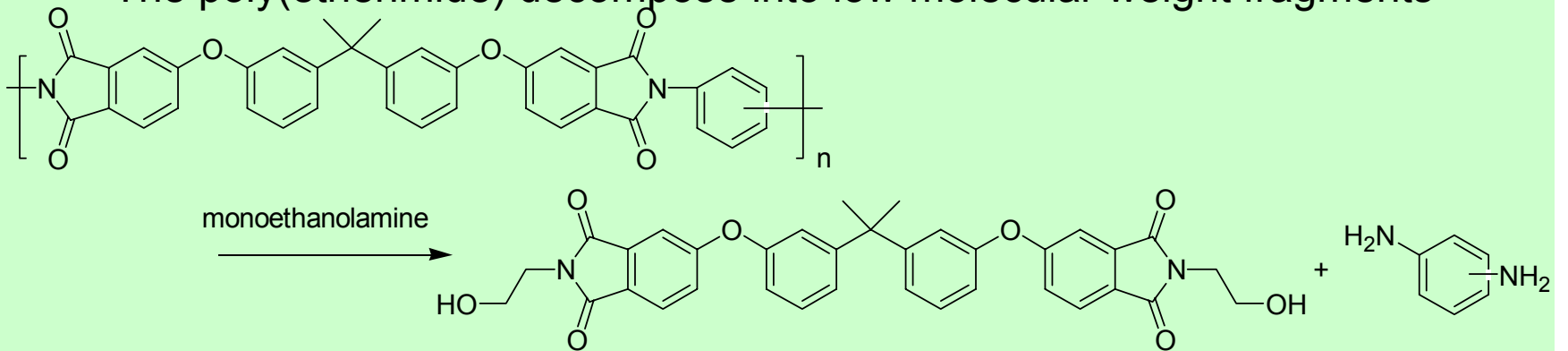

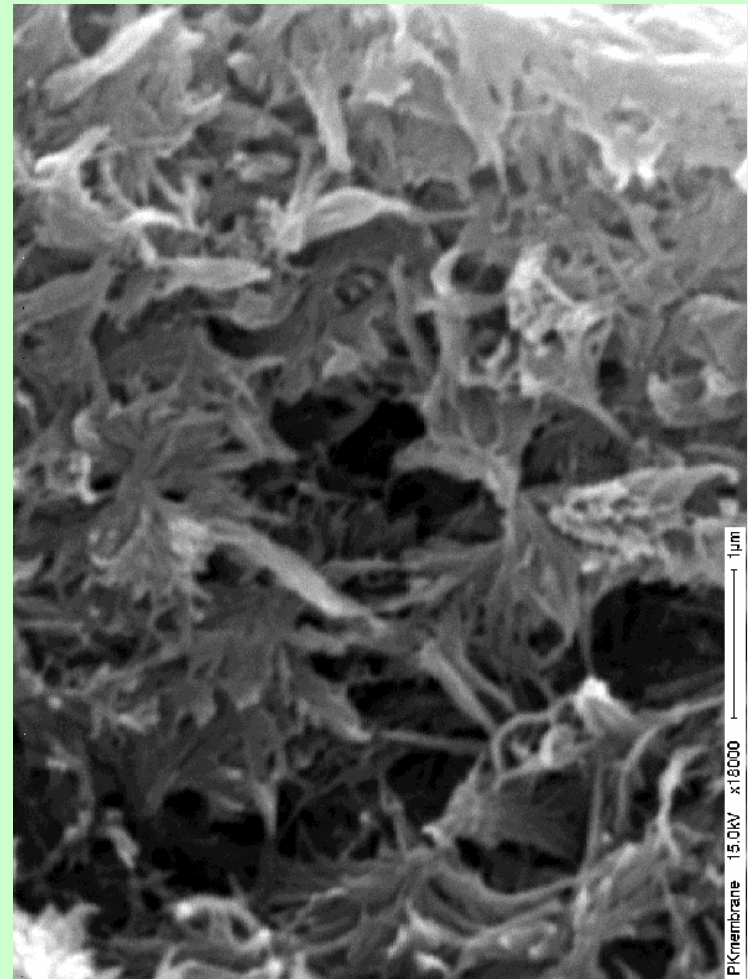
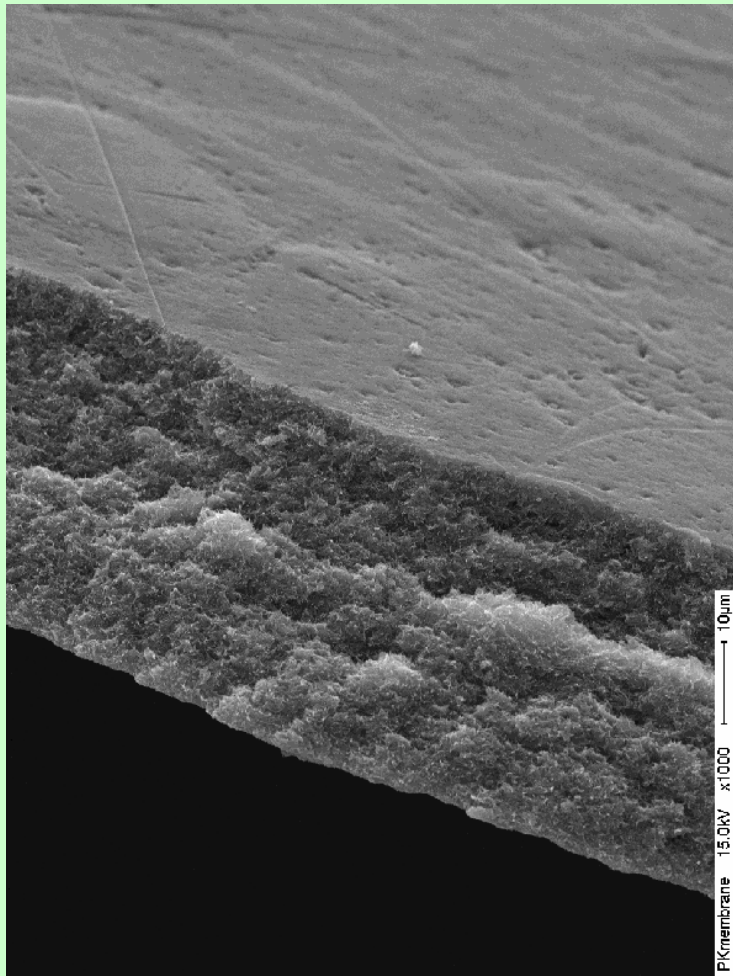

Highly Crystalline Pours PEEK  
a Precursor for Carbon

# Technical Approach

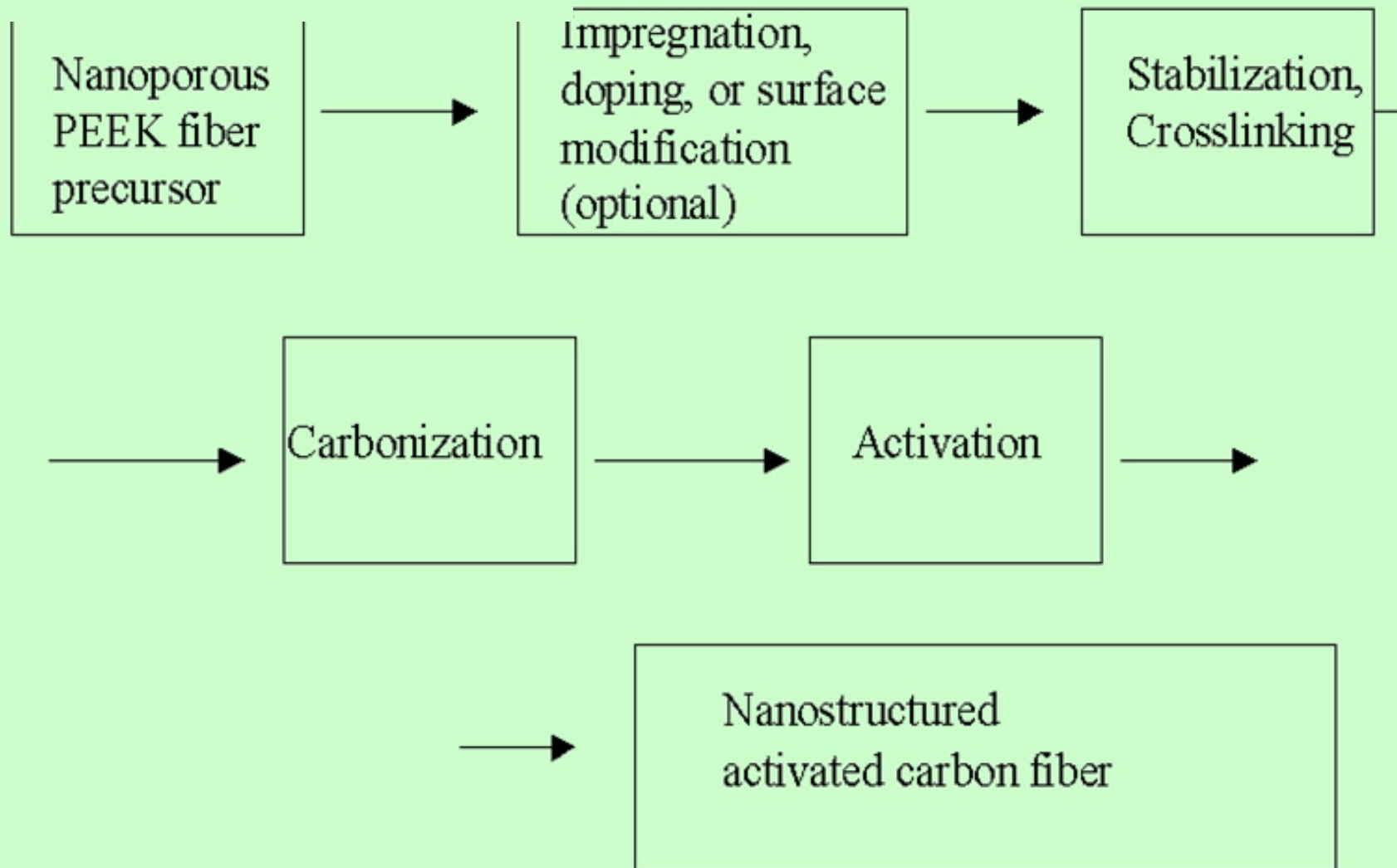

**The Nanostructured Activated Carbon Fiber Preparation Methodology**

# PEEK Carbon Fiber

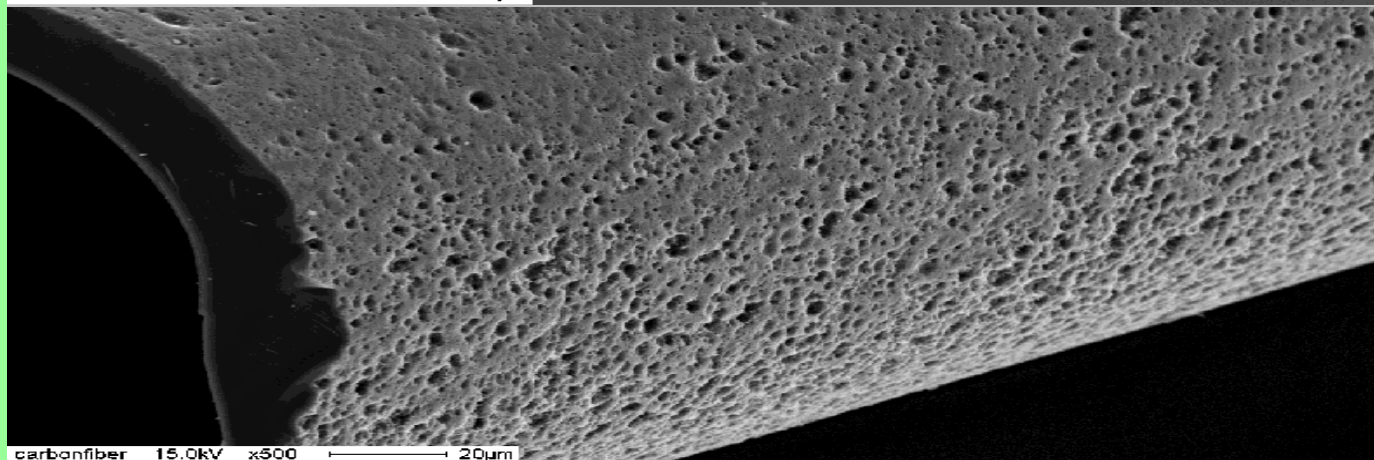
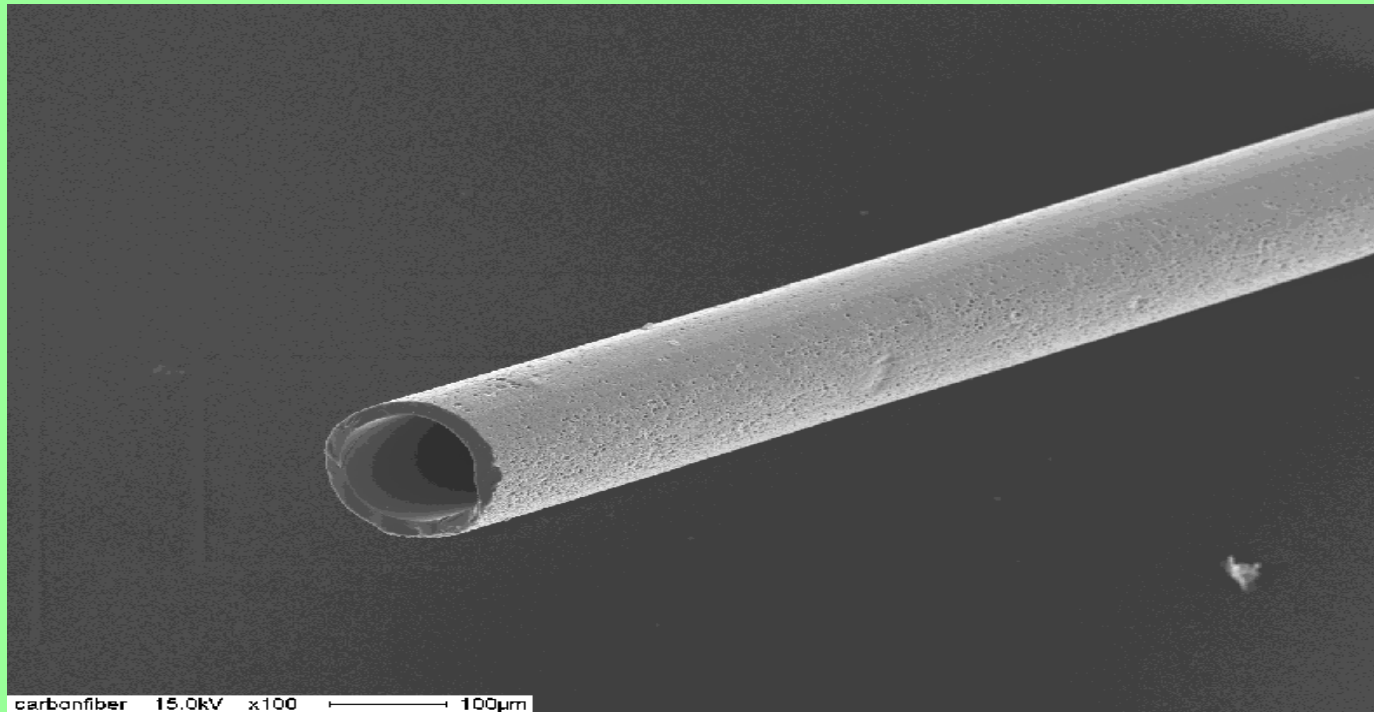

# AFM images of carbon powder < 2 nm pores

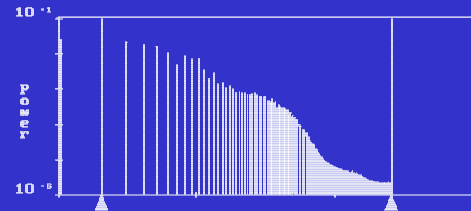
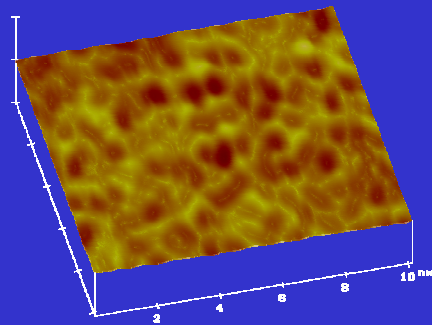
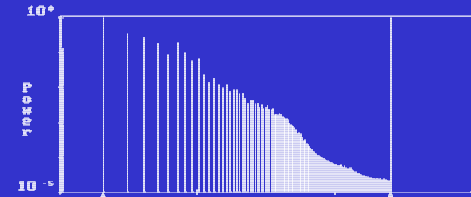
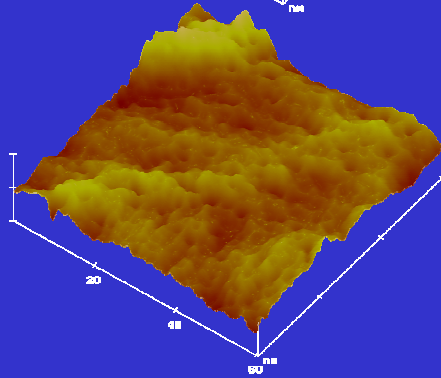
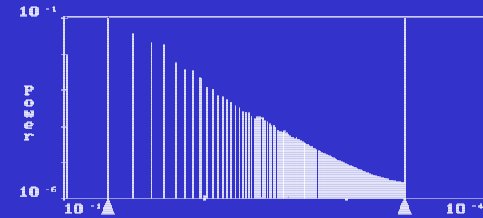
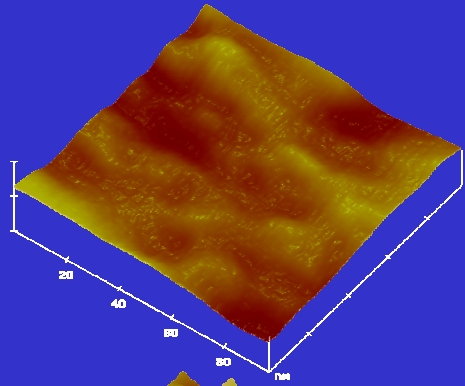

Different stage of pore formation in polymer carbon: 500, 110 and 3100 cm<sup>2</sup>/g



## **Hydrogen Storage (Physisorption & Chemisorption)**

Pore size distribution determines to the storage characteristic.

**Physisorption in carbon/PEEK** H<sub>2</sub> adsorption is being progressively maximized as pores' diameter is decreased,

We have demonstrated the preparation of microporous carbons with a surface area in excess of 3000 m<sup>2</sup>/g. Such exceptionally high surface area leads to capillary-like condensation during high-pressure operation. The correlation between *surface area/ pore size distribution* and *storage* is being study.

**Chemisorption** Reactive sites can be incorporated into the pores of active carbon/PEEK to promote significant increase in hydrogen sorption. The incorporation organometallics and metal oxide doped carbon in to catalytic sites containing heteroatoms such as N, P, S and B are being investigated.

# Adsorption Isotherms of N<sub>2</sub> at 77 K on Microporous PEEK Carbons

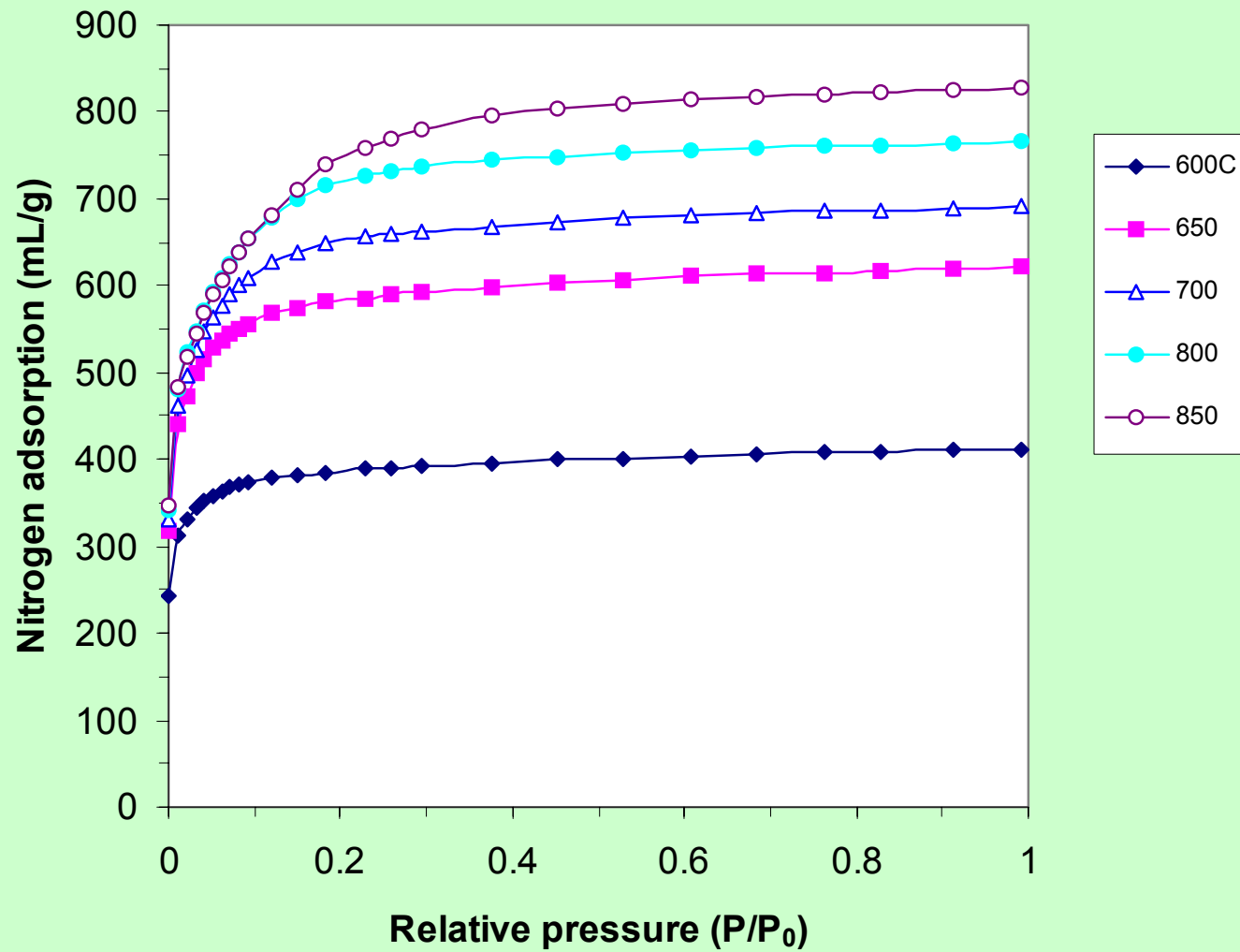

# Pore size distribution of activated PEEK carbons

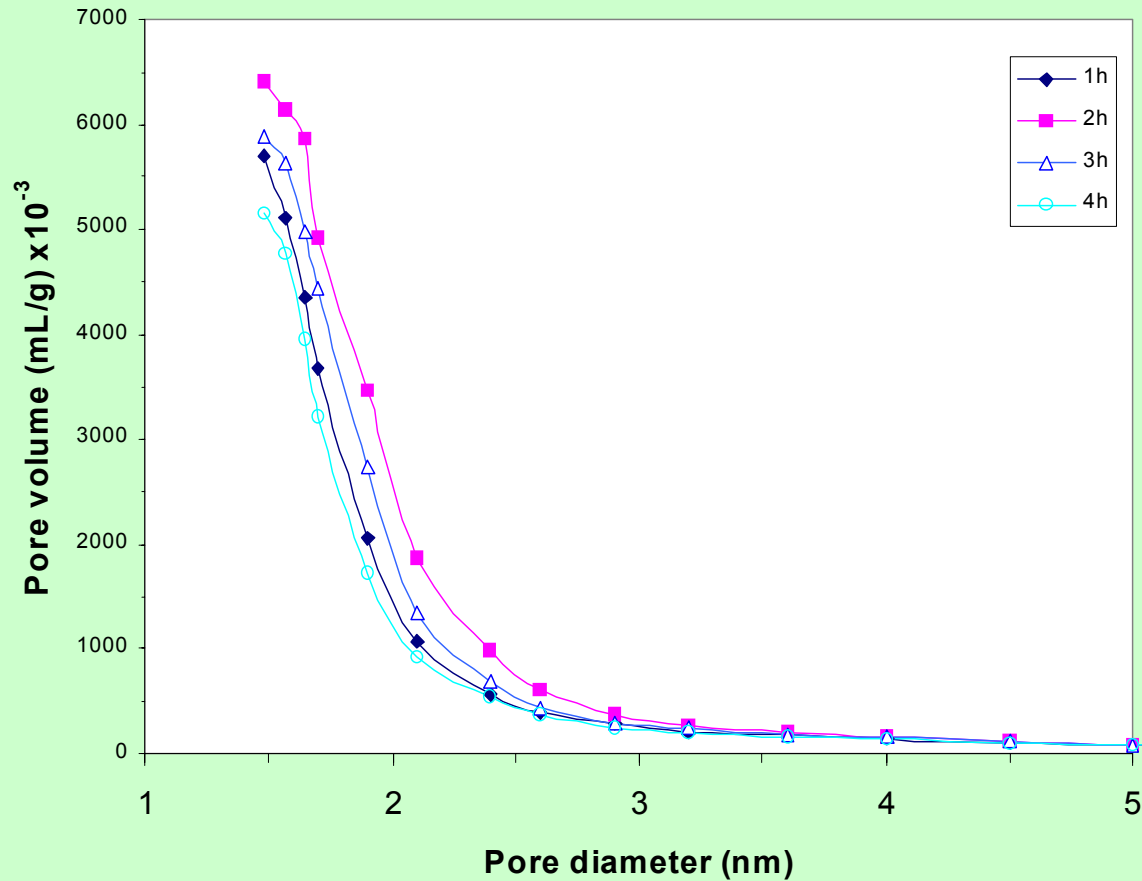



# The effect of the ratio of hydroxide to carbon on the specific surface area of activated PEEK carbons

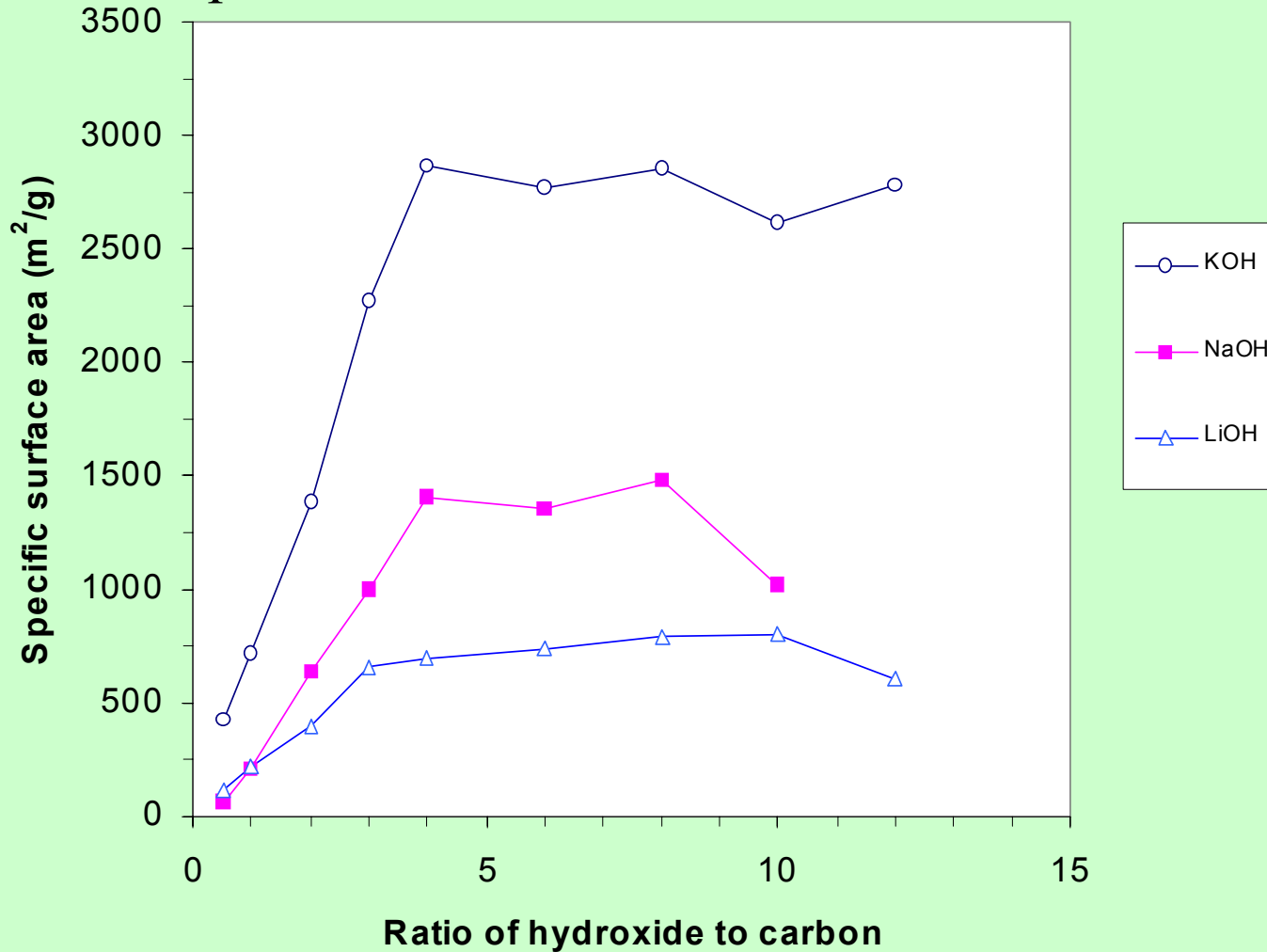

# The relationship between micropore volume and specific surface area of activated PEEK carbons

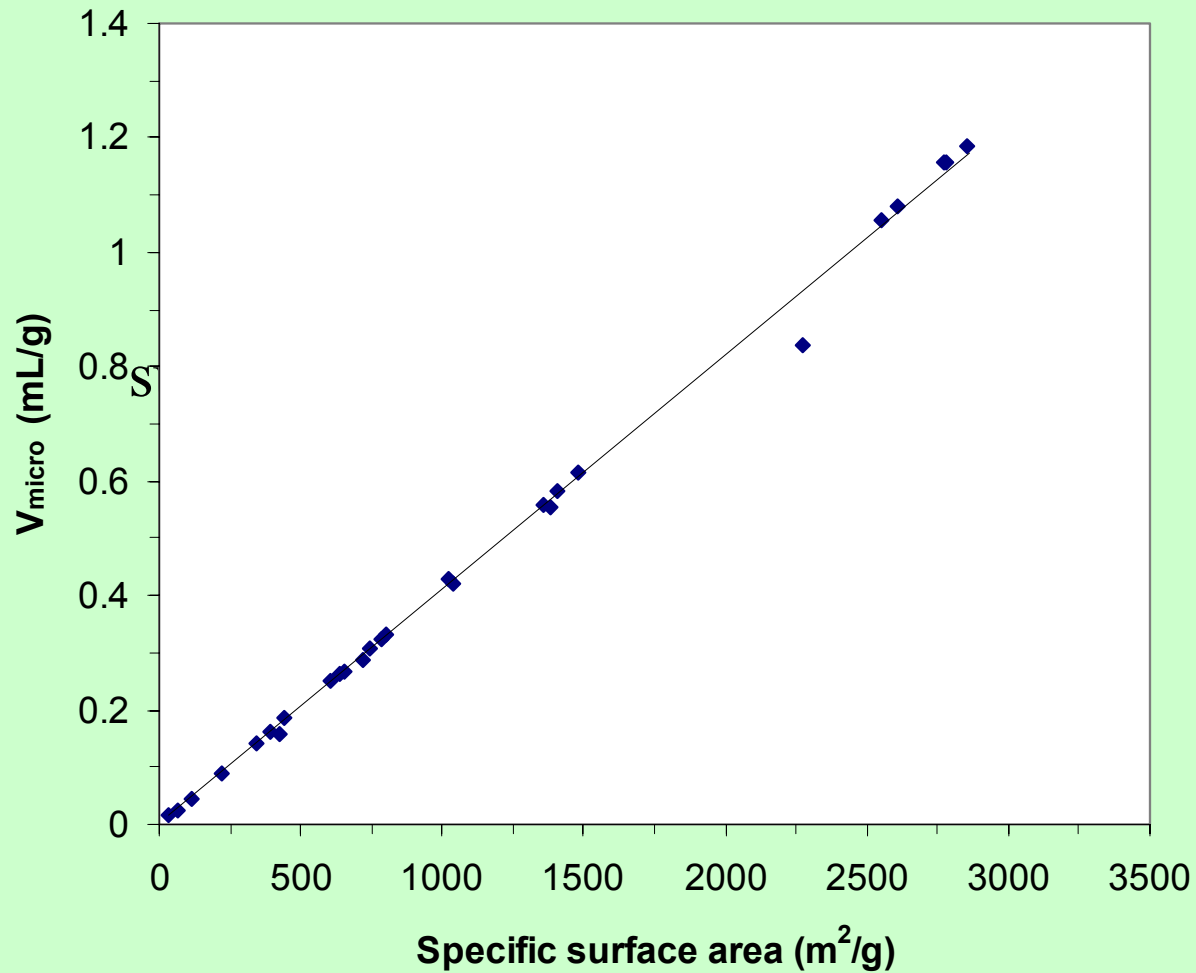

# The change of pore size with surface area of activated PEEK carbons

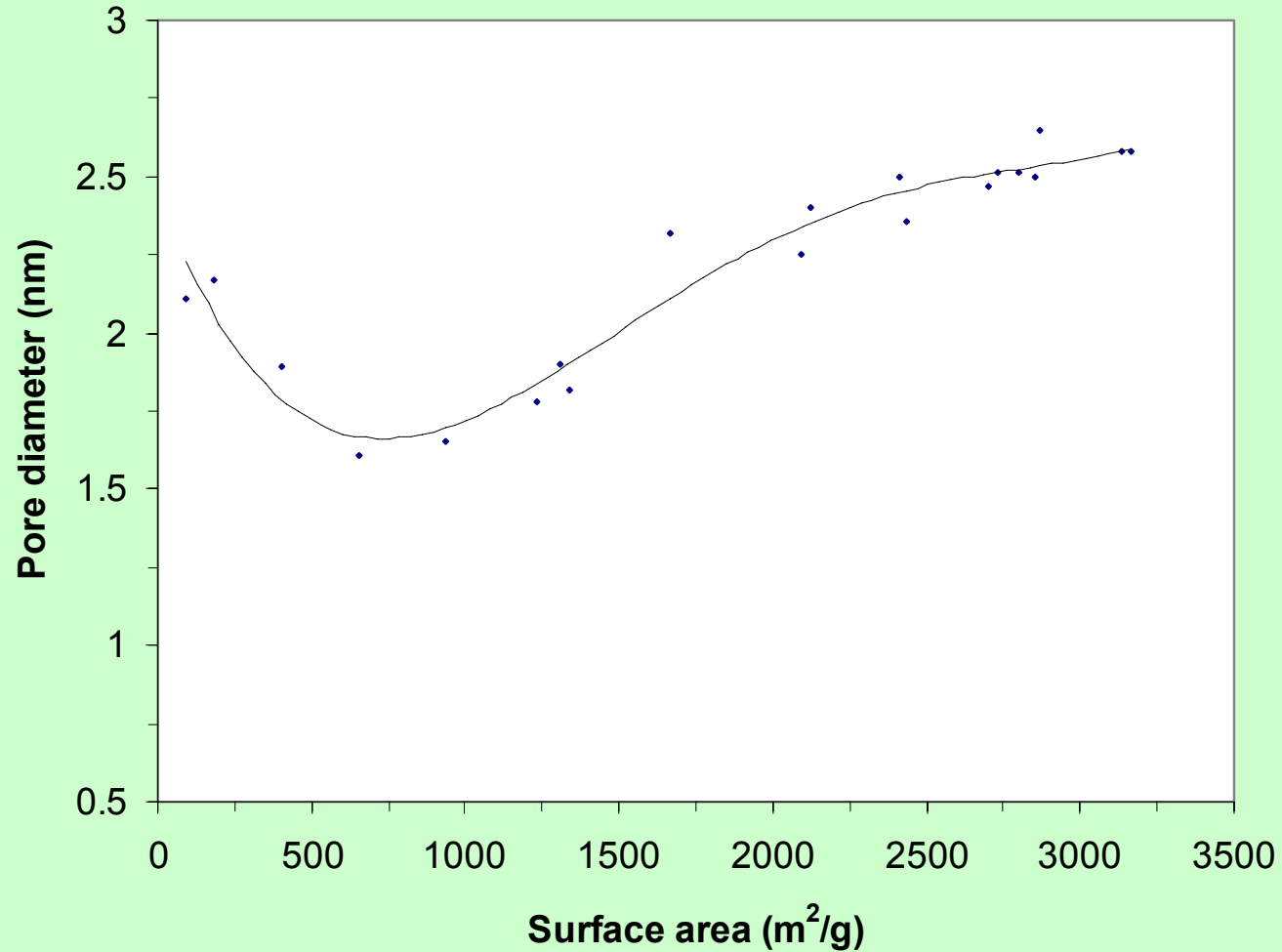

# The change of hydrogen adsorption at 77K and 1 bar with the specific surface area of activated PEEK carbons

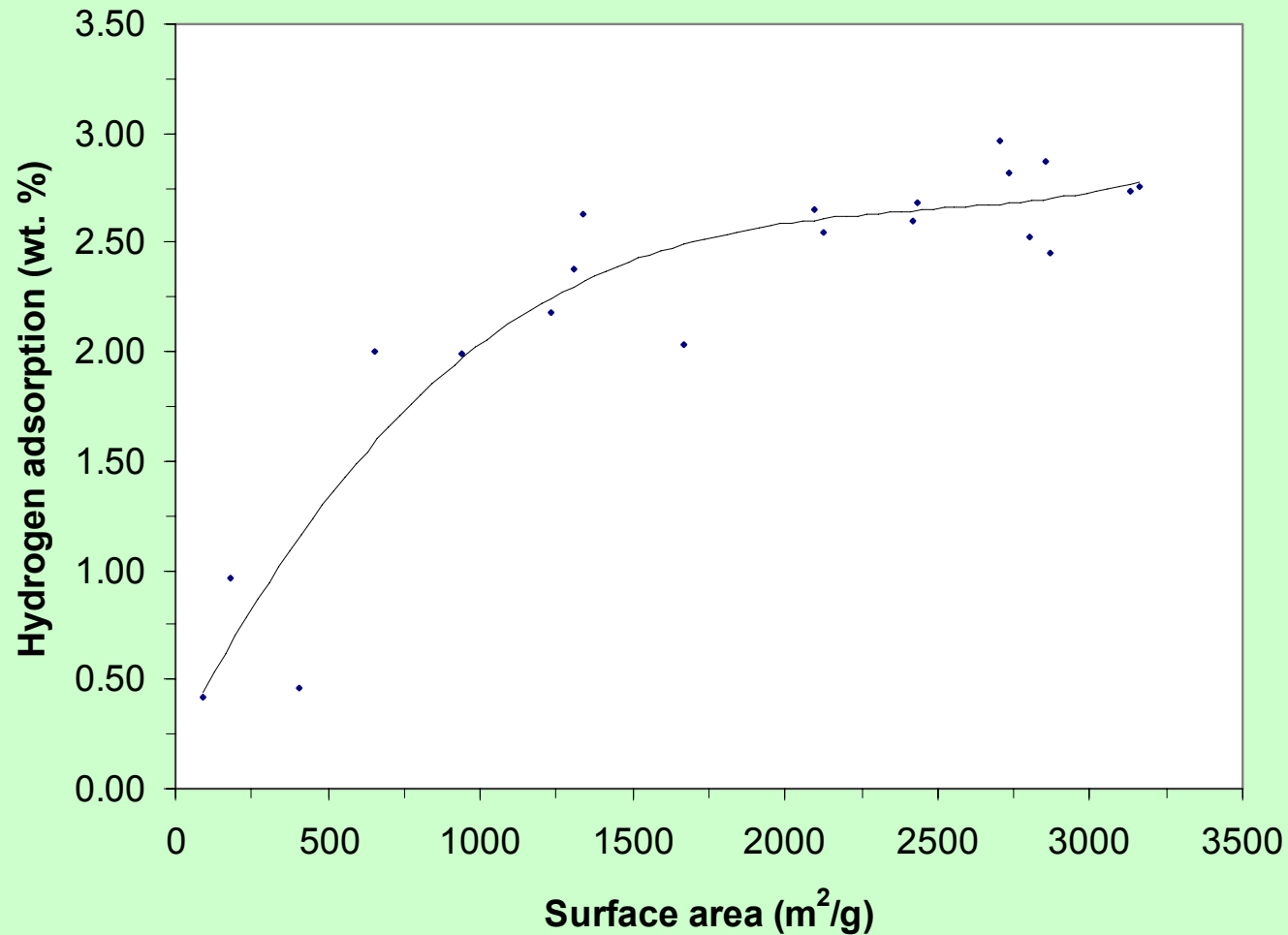

# The effect of pore size on the hydrogen adsorption on per unit surface area of activated PEEK carbons

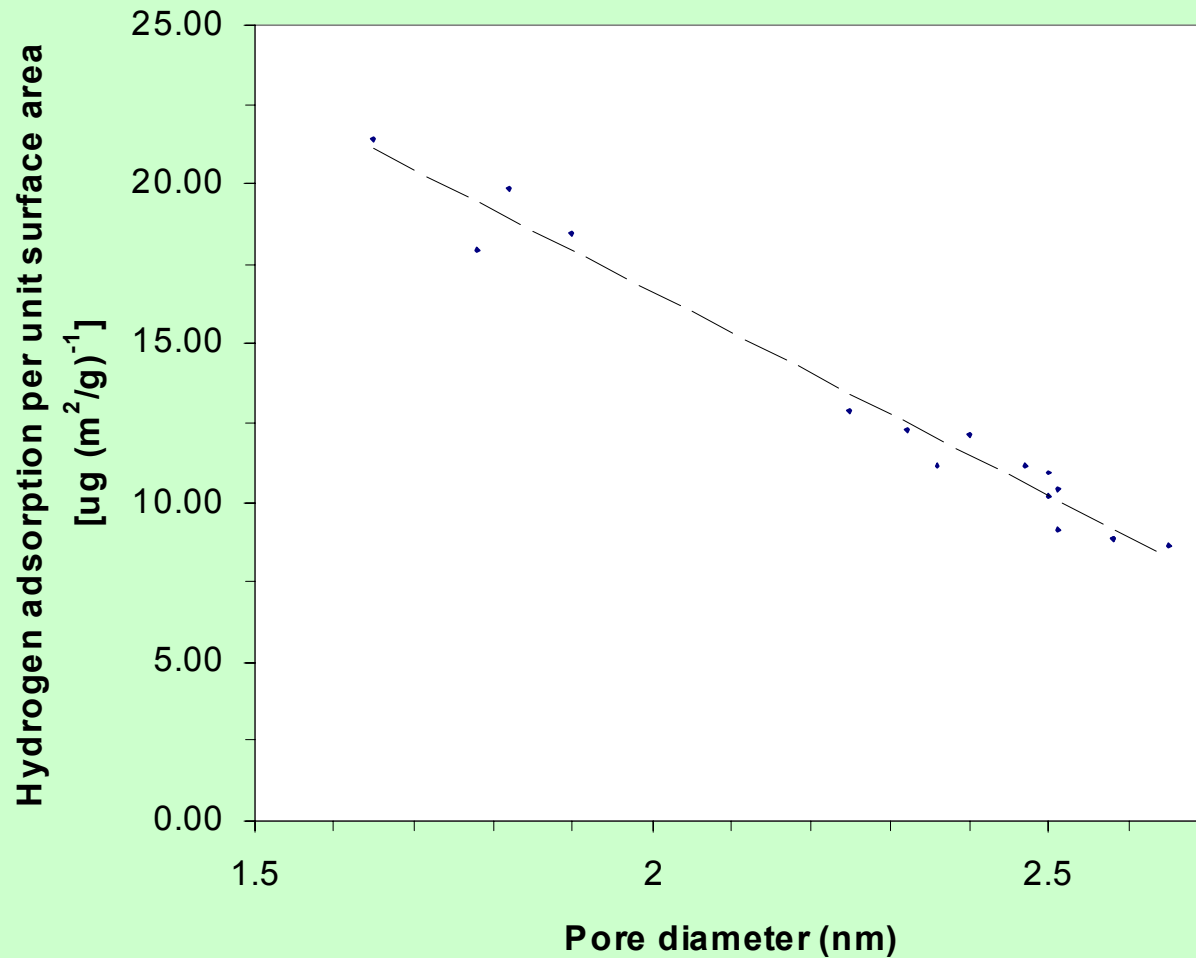

# Project Safety

The project is conducted with appropriated safety regulations and standards in respect to technologies operating procedures.

All the preparation and process of carbon are performed in fume hoods.

Hydrogen adsorption operations have built-in safety alarms and electronic shutdown.

The laboratories are regulated by SUNY safety regulations and inspected routinely N.Y. state inspector.

All chemical hazardous wastes are deposed according to the EPA chemical waste guidelines.

## **Future Work**

Planned work for FY06 (see Time Line slide):

The portion of the planned work that had been for FY05 and could not be completed because of DOE's budget constraints will be finished, We hope to resume work as scheduled in the original timeline with emphasis on:

Nanoporous PEEK material modification

Nanoporous PEEK material characterization

Nano structured activated carbon preparation

Nano structured activated carbon characterization

Activated carbon analytic characterization with organometallic compounds..

Low temperature hydrogen adsorption test